

# JST Products for LED Lighting

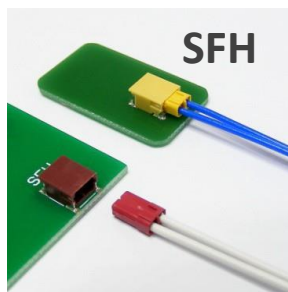
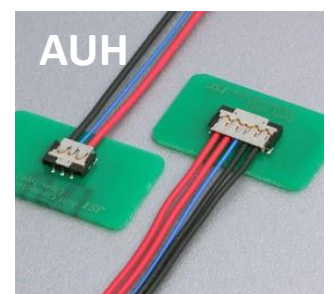
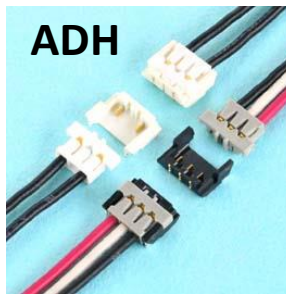
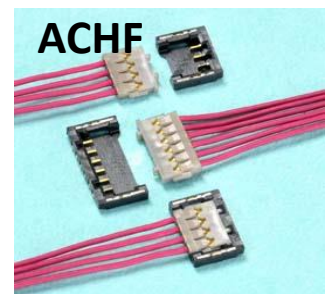
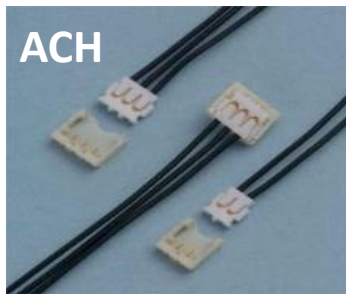
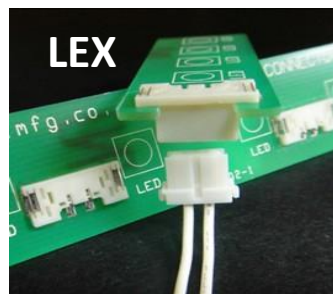
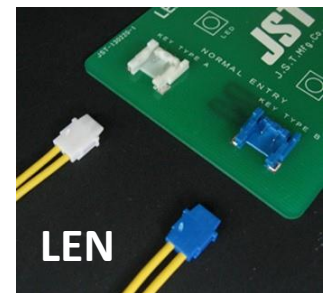
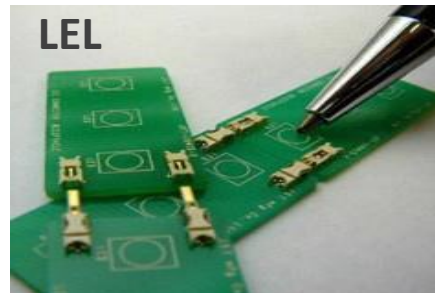
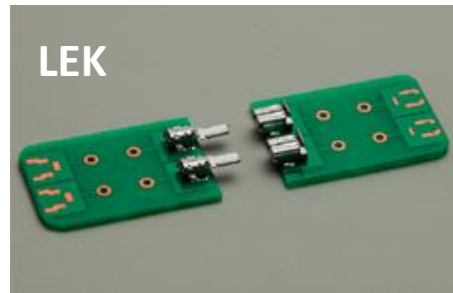
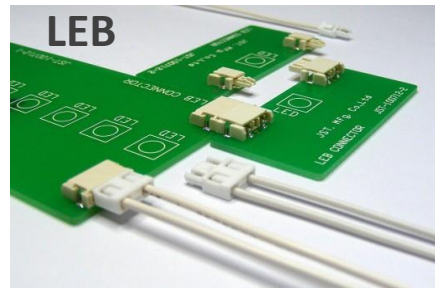
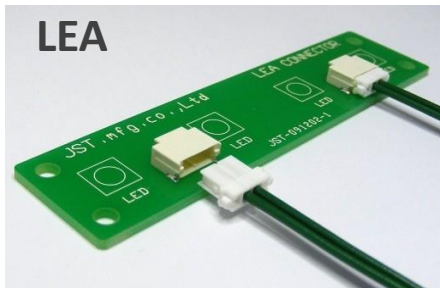

**JST Sales America**

1957 South Lakeside Dr.  
Waukegan, IL 60085  
Tel: 800-947-1110  
Fax: 847-473-0-144

Email: [Tac@jst.com](mailto:Tac@jst.com)

Website: [www.jst.com](http://www.jst.com)

# Table of Contents

Series Name	Pitch	No. of Circuits	Current Rating*	Voltage Rating	AWG Range	BtB	WtB	WtW
LEA	1.8 mm	2	3.0A	300V AC/DC	AWG 30-22		X	
LEB	4.0 mm	1 + 2	3.0A	300V AC/DC	AWG 26-22	X	X	
LEH	1.8 mm	2	3.0A	300V AC/DC	AWG 26-22		X	
LEK	N/A	1	3.0A		N/A	X		
LEL		1	1.6A	100V AC/DC		X		
LEN	3.0 mm	2 + 3	3.0A	300V AC/DC	AWG 26-22		X	
LEX	2.5 mm	2	3.0A	300V AC/DC	AWG 30-22		X	
ACH	1.2 mm	1, 2, 3, 4	2A 1.5A	50V AC/DC	AWG 30-28		X	X
ACHF	1.2mm	3, 4, 6	1.0A (signal) 2.5A (power)	50V	AWG 30-28		X	
ACHL	1.2mm	2	2.0A	50V	AWG 30-28		X	
ADH	1.3	3	3.0A	30V	AWG 28-26		X	
AUH	1.85 mm	3 + 5	1.0A (signal) 5.0A (power)	30V AC/DC	AWG 30-22		X	
SFH	1.8 mm	2	4.0A	350V AC/DC	AWG 30-22		X	

\* depends on wire range / circuit no.

## LEA connector

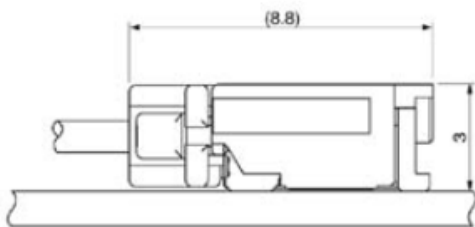
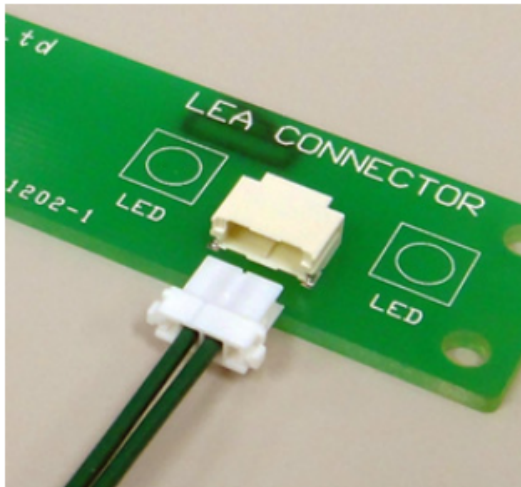

Considering that the connector does not affect the luminescence angle of LED chip, this low profile type connector (height:3.0 mm) is designed for connection to LED lamp and realized space saving. A secure locking mechanism is arranged to this connector in order to consider the handling of wire in actual use, although this is a low profile.

### Product Profile

Series	LEA connector
Category	Wire to Board Crimp style Connectors
Type	Crimp style, Disconnectable type Crimp style, Compact type, With secure locking device
Feature	For LED lamp

### Specification

Pitch	1.8 mm
Current rating	3A
Voltage rating	300V

Compliant with RoHS.

(LF)(SN) as identification part number shall be displayed on a label. When ordering RoHS compliant products, please inquire to the nearest JST Sales Office, or order them with the described part number adding (LF)(SN) as the identification marking after it.



### JST Sales America

1957 South Lakeside Dr.  
Waukegan, IL 60085  
Tel: 800-947-1110  
Fax: 847-473-0-144

Email: [Tac@jst.com](mailto:Tac@jst.com)

Website: [www.jst.com](http://www.jst.com)

## LEB connector

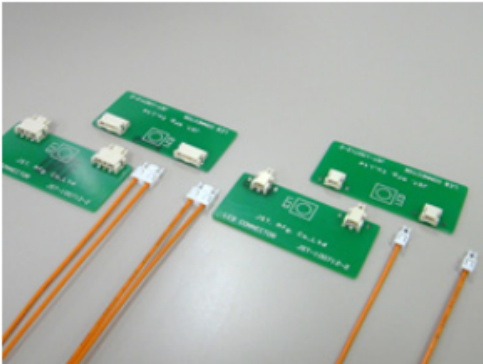

Considering about luminescence property of LED device, this LEB connector is designed as low profile type connector (height: 2.7mm) for LED lighting, and achieves the space saving. The horizontal connection between PCBs enables and the mechanism of absorbing the PCB misalignment has been installed considering the parallel use for the connector. Fork type contact that has a high contact pressure (receptacle side) and enough mating stroke provide the stable contact performance even if the PCB expands and contracts due to heat.

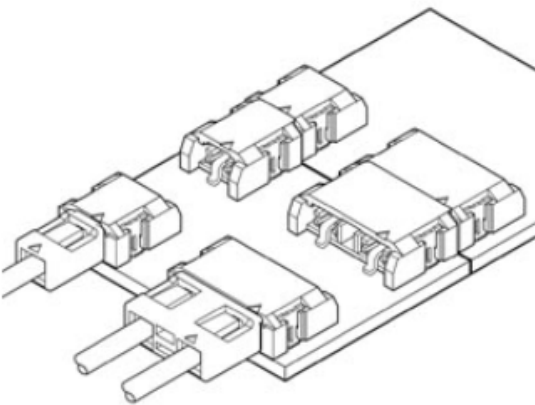

### Product Profile

Series	LEB connector
Category	Board to Board Connectors
Type	Crimp style, Disconnectable type Absorbing PC board misalignment type, PC board horizontal mounting type
Feature	For LED lamp

### Specification

Pitch	4.0 mm
Current rating	3A
Voltage rating	300V



### JST Sales America

1957 South Lakeside Dr.  
Waukegan, IL 60085  
Tel: 800-947-1110  
Fax: 847-473-0-144

Email: [Tac@jst.com](mailto:Tac@jst.com)  
Website: [www.jst.com](http://www.jst.com)

## LEH connector

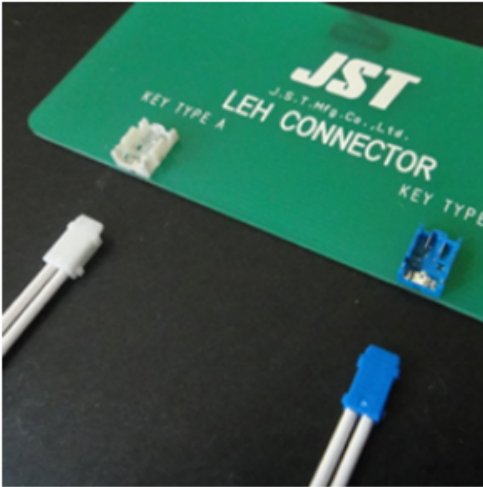

Considering about the luminescence property of LED package and the mating operability, this LEH connector is designed as low profile type connector for LED lighting, and achieves the space saving.. In consideration of connector mating operation to the LED mounting PCB that is integrated in the equipment, side-feed mechanism that provides to enable mating the connector from right above is adopted, and secure lock and mechanism for preventing wrong insertion are provided.

### Product Profile

Series	LEH connector
Category	Wire to Board Crimp style Connectors
Type	Crimp style, Disconnectable type Crimp style, With secure locking device
Feature	For LED lamp

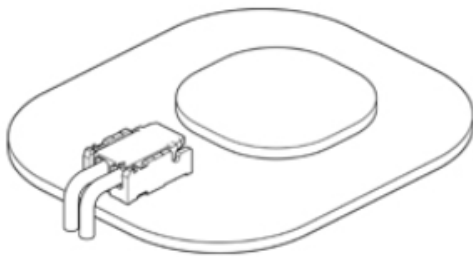

### Specification

Pitch	1.8 mm
Current rating	3A (AWG#22)
Voltage rating	300V



### JST Sales America

1957 South Lakeside Dr.  
Waukegan, IL 60085  
Tel: 800-947-1110  
Fax: 847-473-0-144

Email: [Tac@jst.com](mailto:Tac@jst.com)

Website: [www.jst.com](http://www.jst.com)

## LEK connector

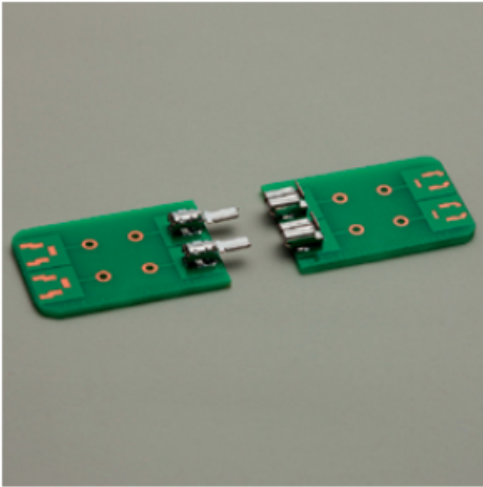

This LEK connector is board-to-board connector that does not use the housing and has a positive lock. This enables to absorb misalignment when mating connector.

### Product Profile

Series	LEK connector
Category	Board to Board Connectors
Type	Absorbing PC board misalignment type, PC board horizontal mounting type
Feature	With secure locking device

### Specification

Current rating	3A
----------------	----

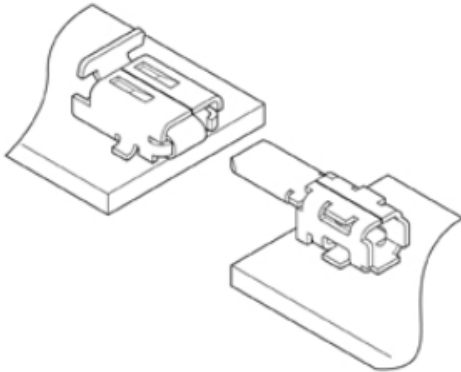

Compliant with RoHS.

(LF)(SN) as identification part number shall be displayed on a label.

When ordering RoHS compliant products, please inquire to the nearest JST Sales Office, or order them with the described part number adding (LF)(SN) as the identification marking after it.



### JST Sales America

1957 South Lakeside Dr.  
Waukegan, IL 60085  
Tel: 800-947-1110  
Fax: 847-473-0-144

Email: [Tac@jst.com](mailto:Tac@jst.com)

Website: [www.jst.com](http://www.jst.com)

## LEL connector

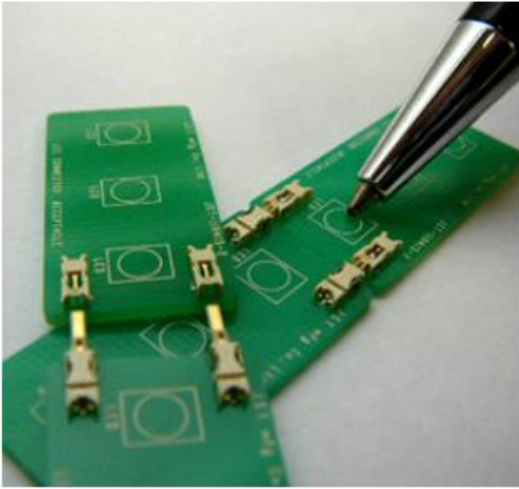

Considering about luminescence property of LED package, this LEL connector is designed as low profile type connector for LED lighting, and achieves the space saving. The horizontal connection between PCBs enables and the mechanism of absorbing the PCB misalignment has been installed considering the parallel use for the connector. Bellows type contact that has a high contact pressure and a high durability performance (receptacle side) and enough mating stroke provides the stable contact performance even if the PCB expands and contracts due to heat.

### Product Profile

Series	LEL connector
Category	Board to Board Connectors
Type	Absorbing PC board misalignment type, PC board horizontal mounting type
Feature	For LED lamp

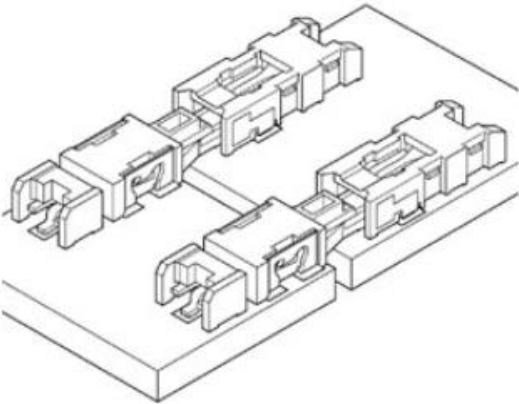

### Specification

Current rating	1.6A
Voltage rating	100V



### JST Sales America

1957 South Lakeside Dr.  
Waukegan, IL 60085  
Tel: 800-947-1110  
Fax: 847-473-0-144

Email: [Tac@jst.com](mailto:Tac@jst.com)  
Website: [www.jst.com](http://www.jst.com)

## LEN connector

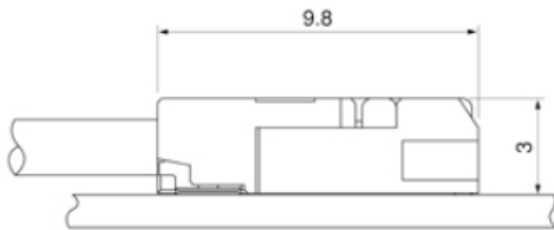
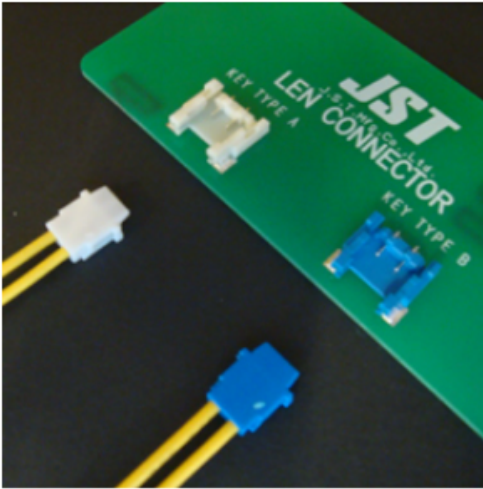

Considering about the luminescence property of LED package, this LEN connector is designed as low profile type connector for LED lighting. In consideration of connector mating operation to the LED mounting PCB that is integrated in the equipment, side-feed mechanism that provides to enable mating the connector from above is adopted, and secure lock that considered handling and mechanism for preventing wrong insertion are provided.

### Product Profile

Series	LEN connector
Category	Wire to Board Crimp style Connectors
Type	Crimp style, Disconnectable type Crimp style, With secure locking device
Feature	For LED lamp

### Specification

Pitch	3.0 mm
Current rating	3A (AWG#22)
Voltage rating	300V



### JST Sales America

1957 South Lakeside Dr.  
Waukegan, IL 60085  
Tel: 800-947-1110  
Fax: 847-473-0-144

Email: [Tac@jst.com](mailto:Tac@jst.com)

Website: [www.jst.com](http://www.jst.com)

## LEX connector

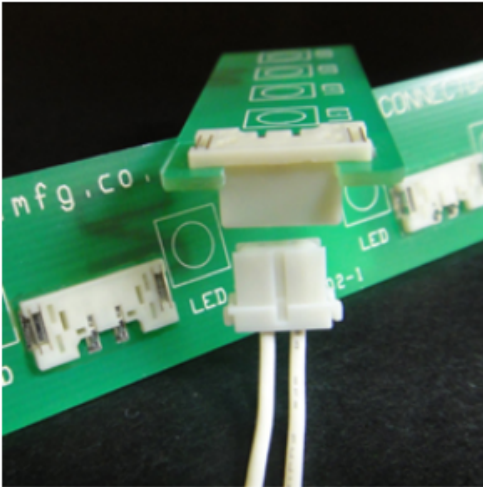

Considering about luminescence property of LED package, this LEX connector is designed as low profile bottom type connector for LED lighting equipment, and achieves the space saving at the connector mounting side. In consideration of connector mating operation, secure lock and mechanism for preventing wrong insertion are provided. With the assumption that the load may be applied to the soldering part when mating the connector, the strength of soldering part after mounting the connector on PCB has been largely improved.

### Product Profile

Series	LEX connector
Category	Wire to Board Crimp style Connectors
Type	Crimp style, Disconnectable type Crimp style, With secure locking device
Feature	For LED lamp

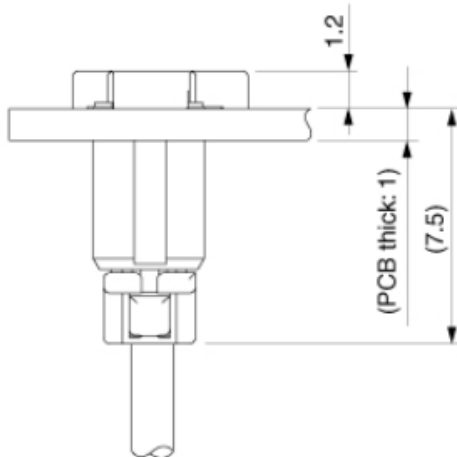

### Specification

Pitch	2.5 mm
Current rating	3A (AWG#22)
Voltage rating	300V



### JST Sales America

1957 South Lakeside Dr.  
Waukegan, IL 60085  
Tel: 800-947-1110  
Fax: 847-473-0-144

Email: [Tac@jst.com](mailto:Tac@jst.com)  
Website: [www.jst.com](http://www.jst.com)

## ACH connector

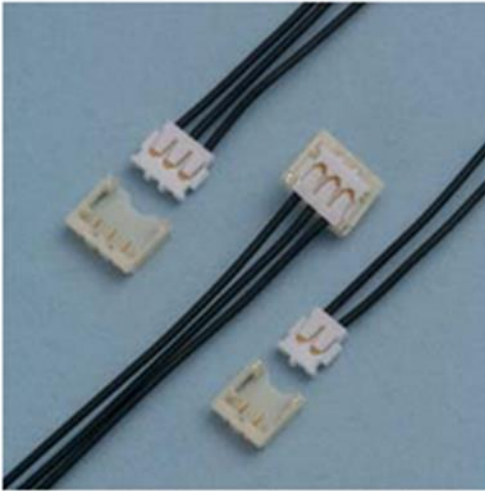

This connector is compact and low profile type, height: 1.4mm and width 4.3mm, 1.2mm pitch wire-to-board connector.

### Product Profile

Series	ACH connector
Category	Wire to Board Crimp style Connectors
Type	Disconnectable type Crimp style, Compact type, Low-profile type
Feature	For LED lamp

### Specification

Pitch	1.2 mm
Current rating	2A/1to3-circuit (AWG#28) 1.5A/4-circuit (AWG#28)
Voltage rating	50V
PC board mounting direction	Top entry

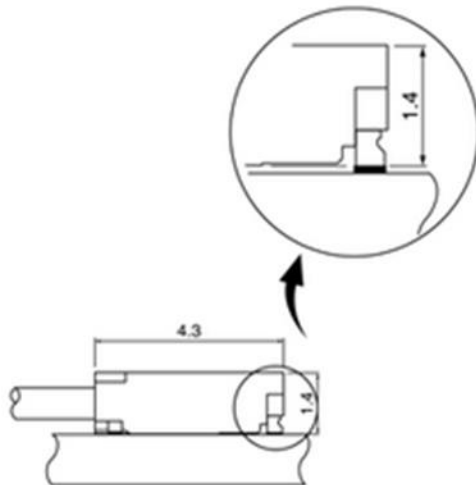

Compliant with RoHS.

(LF)(SN) as identification part number shall be displayed on a label. When ordering RoHS compliant products, please inquire to the nearest JST Sales Office, or order them with the described part number adding (LF)(SN) as the identification marking after it.



### JST Sales America

1957 South Lakeside Dr.  
Waukegan, IL 60085  
Tel: 800-947-1110  
Fax: 847-473-0-144

Email: [Tac@jst.com](mailto:Tac@jst.com)

Website: [www.jst.com](http://www.jst.com)

## ACHF Connector



This ACHF connector is compact and low profile type, height 1.43mm and width 4.95mm, 1.2 pitch wire-to-board connector.

### Product Profile

Series	ACHF Connector
Category	Wire to Board Crimp style Connectors
Type	Crimp style, Disconnectable type Crimp style, Compact type, Low-profile type
Feature	Low-profile

### Specification

Pitch	1.2 mm
Current rating	2.5A (AWG#28)
Voltage rating	50V

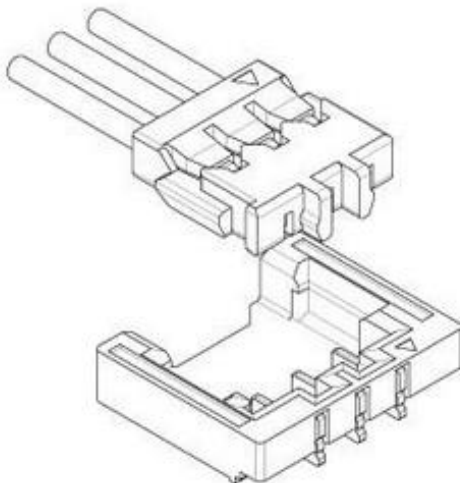

Compliant with RoHS.

(LF)(SN) as identification part number shall be displayed on a label.

When ordering RoHS compliant products, please inquire to the nearest JST Sales Office, or order them with the described part number adding (LF)(SN) as the identification marking after it.



### JST Sales America

1957 South Lakeside Dr.  
Waukegan, IL 60085  
Tel: 800-947-1110  
Fax: 847-473-0-144

Email: [Tac@jst.com](mailto:Tac@jst.com)

Website: [www.jst.com](http://www.jst.com)

## ACHL connector

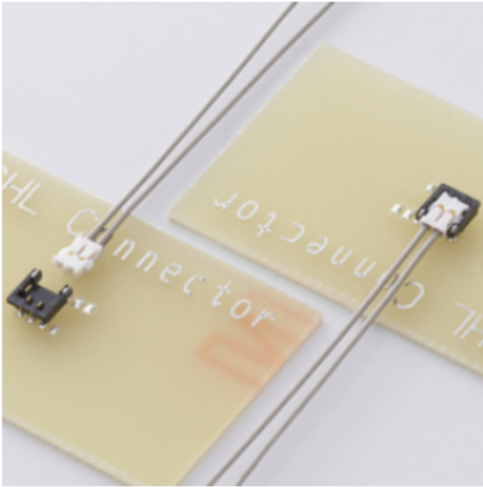

This connector is compact and low profile type, height 1.2mm and width 4.7mm, 1.2mm pitch wire-to-board connector.

### Product Profile

Series	ACHL connector
Category	Wire to Board Crimp style Connectors
Type	Disconnectable type Crimp style, Compact type, Low-profile type
Feature	Low-profile

### Specification

Pitch	1.2 mm
Current rating	2A (AWG#28)
Voltage rating	50V

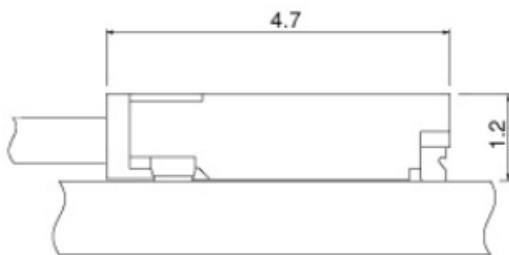

Compliant with RoHS.

(LF)(SN) as identification part number shall be displayed on a label.

When ordering RoHS compliant products, please inquire to the nearest JST Sales Office, or order them with the described part number adding (LF)(SN) as the identification marking after it.



### JST Sales America

1957 South Lakeside Dr.  
Waukegan, IL 60085  
Tel: 800-947-1110  
Fax: 847-473-0-144

Email: [Tac@jst.com](mailto:Tac@jst.com)

Website: [www.jst.com](http://www.jst.com)

## ADH Connector



This ADH connector is compact and low profile type, height 1.9mm and width 4.3mm, 1.3 pitch wire-to-board connector.

### Product Profile

Series	ADH Connector
Category	Wire to Board Crimp style Connectors
Type	Crimp style, Disconnectable type Crimp style, Compact type, Low-profile type
Feature	Low-profile

### Specification

Pitch	1.3 mm
Current rating	3A (AWG#26)
Voltage rating	30V

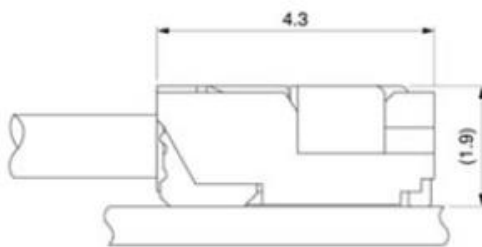

Compliant with RoHS.

(LF)(SN) as identification part number shall be displayed on a label. When ordering RoHS compliant products, please inquire to the nearest JST Sales Office, or order them with the described part number adding (LF)(SN) as the identification marking after it.



### JST Sales America

1957 South Lakeside Dr.  
Waukegan, IL 60085  
Tel: 800-947-1110  
Fax: 847-473-0-144

Email: [Tac@jst.com](mailto:Tac@jst.com)

Website: [www.jst.com](http://www.jst.com)

## AUH Connector

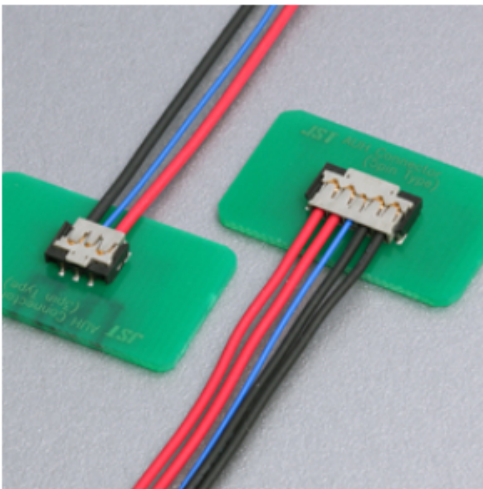

This AUH connector is compact and low profile type, height 1.85mm and width 5.2mm, wire-to-board connector. And also 5A in rating current was realized.

### Product Profile

Series	AUH Connector
Category	Wire to Board Crimp style Connectors
Type	Crimp style, Disconnectable type Crimp style, Compact type, Low-profile type
Feature	Low-profile

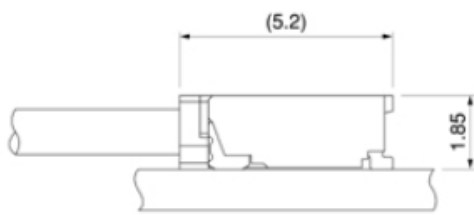

### Specification

Current rating	Power supply circuit/5A (AWG#22) Signal circuit/1A
Voltage rating	30V

Compliant with RoHS.

(LF)(SN) as identification part number shall be displayed on a label.

When ordering RoHS compliant products, please inquire to the nearest JST Sales Office, or order them with the described part number adding (LF)(SN) as the identification marking after it.



### JST Sales America

1957 South Lakeside Dr.  
Waukegan, IL 60085  
Tel: 800-947-1110  
Fax: 847-473-0-144

Email: [Tac@jst.com](mailto:Tac@jst.com)

Website: [www.jst.com](http://www.jst.com)

## SFH connector

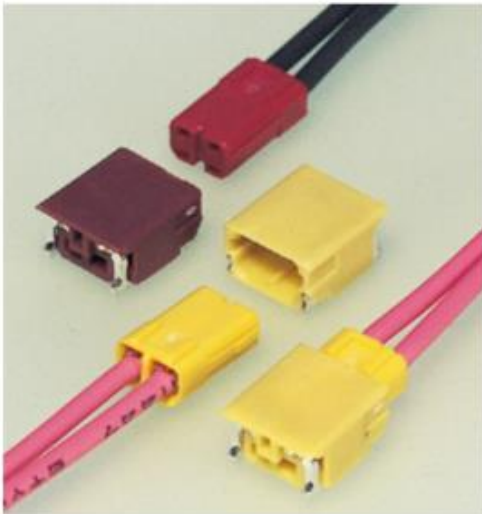

This low profile type connector with height of 3.0mm is designed for connection to stroboscope flash and realized space saving.

### Product Profile

Series	SFH connector
Category	Wire to Board Crimp style Connectors
Type	Disconnectable type Crimp style, Compact type, Low-profile type
Feature	High withstanding voltage

### Specification

Pitch	1.8 mm
Current rating	4A (AWG#22)
Voltage rating	350V
PC board mounting direction	Side entry

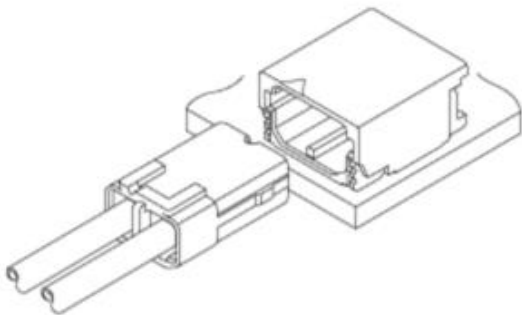

### JST Sales America

1957 South Lakeside Dr.  
Waukegan, IL 60085  
Tel: 800-947-1110  
Fax: 847-473-0-144

Email: [Tac@jst.com](mailto:Tac@jst.com)  
Website: [www.jst.com](http://www.jst.com)