

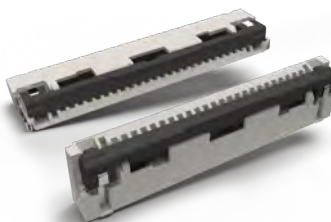

CONNECTOR SELECTOR PRODUCT GUIDE

WIRE-TO-BOARD | WIRE-TO-WIRE | BOARD-TO-BOARD | FPC/FFC | SPECIALTY APPLICATIONS

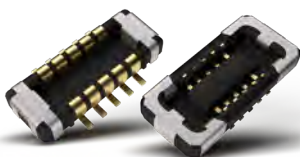
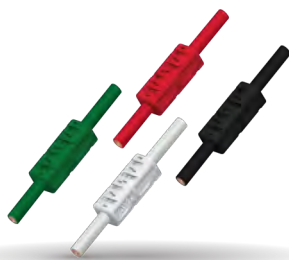

CONNECTOR SELECTOR

TABLE OF CONTENTS



TABLE OF CONTENTS

4 **ABOUT US | DECADES OF TECHNOLOGY**

Our History

5-8 **(WTB) | WIRE-TO-BOARD**

Insulation Displacement Technology
Poke-Home Technology
2-Piece Connectors
Fine-Pitch Technology

9 **(WTW) | WIRE-TO-WIRE**

Poke-Home Technology

10-15 **(BTB) | BOARD-TO-BOARD**

Compression / Battery Technology
2-Piece Connectors
Card-Edge Technology
Fine-Pitch Technology

16-18 **FPC / FFC**

Fine-Pitch Technology

19-21 **SPECIALTY**

Input/Output
Memory Products
Power Terminals
Shield Locks
Branch Connectors

DECADES OF TECHNOLOGY

KYOCERA AVX (formerly AVX Corporation) in October 2021 announced our new brand structure - KYOCERA AVX Components Corporation. This change maximizes the synergies of our two strong brands and combines our resources of manufacturing and development.

We remain a leading international manufacturer and supplier of advanced electronic components with 33 manufacturing facilities in 16 countries around the world. KYOCERA AVX offers a broad range of devices including Capacitors, RF/Microwave Components, Sensors, Controls, Circuit Protection Devices, Connectors and Antennas Solutions.



KYOCERA AVX Connectors (formerly AVX Interconnect) has been producing connectors since 1947. Throughout the years, we have been committed to designing innovative and demanding contact systems. We have been fortunate to create synergies with well-known name brands in the electronics industry. These relationships have enhanced our research and development utilizing new materials and processes that we have integrated into our designs. Our nimble business model and passion toward creative solutions helps us better support our partners and develop problem-solving products.

A list of our "firsts" in the industry:

- Patented (VARIPIN) Eye-of-the-needle compliant press-fit termination. This technology remains popular in automotive applications for critical systems such as passive safety and ABS / ESP.
- VARICON tuning fork hermaphroditic contact system used for over 20 years in military and space applications.
- Cost saving one-piece compression BTB contact technology.
- SMT - Insulation Displacement Contact (IDC) technology for harsh environments.

Our new structure enhances customers' access to KYOCERA's Fine Pitch Technology. This offers customers access to our high-speed floating board to board (FloXY), FPC/FFC, and micro wire to board connectors. KYOCERA AVX expects demand for electronic components to accelerate due to the widespread use of IoT, 5G, and Advanced Driver Assistance Systems, as well as through rapid technological innovation. We expect even more business opportunities brought about by the progression of the "4th Industrial Revolution." Given this broader connector portfolio our entire technical team can offer solutions to customers with varied applications.





CONNECTOR SELECTOR

WIRE-TO-BOARD APPLICATIONS





INSULATION DISPLACEMENT TECHNOLOGY

	Standard (26-30 AWG) 9175-000	
	Application	Discrete Wire
	# of Positions	2 & 3
	Current Rating	1A/Contact
	Voltage Rating	150 VAC
	Operating Temp.	-40°C to +125°C
	Certifications	UL 1977 ROHS

	Capped (26-30 AWG) 9175-700	
	Application	Discrete Wire
	# of Positions	2 & 3
	Current Rating	1A/Contact
	Voltage Rating	150 VAC
	Operating Temp.	-40°C to +125°C
	Certifications	UL 1977 ROHS

	Standard (18-24 AWG) 9176-000	
	Application	Discrete Wire
	# of Positions	1, 2, 3
	Current Rating	Up to 10A/Contact
	Voltage Rating	300 VAC
	Operating Temp.	-40°C to +125°C
Certifications	UL 1977 ROHS	

	Single (22-28 AWG) 9176-400	
	Application	Discrete Wire
	# of Positions	1
	Current Rating	Up to 6A/Contact
	Voltage Rating	Dependent on Contact Spacing
	Operating Temp.	-40°C to +125°C
Certifications	UL 1977 ROHS	

	Single (18-24 AWG) 9176-500	
	Application	Discrete Wire
	# of Positions	1
	Current Rating	Up to 10A/Contact
	Voltage Rating	Dependent on Contact Spacing
	Operating Temp.	-40°C to +125°C
Certifications	UL 1977 ROHS	

	Single Tine PTH (18-24 AWG) 9176-600	
	Application	Discrete Wire
	# of Positions	1
	Current Rating	Up to 9A/Contact
	Voltage Rating	600 VAC
	Operating Temp.	-40°C to +125°C
Certifications	UL 1977 ROHS	

	Single Tine SMT (18-24 AWG) 9176-650	
	Application	Discrete Wire
	# of Positions	1
	Current Rating	Up to 9A/Contact
	Voltage Rating	600 VAC
	Operating Temp.	-40°C to +125°C
Certifications	UL 1977 ROHS	

	Capped (18-24 AWG) 9176-700	
	Application	Discrete Wire
	# of Positions	1 to 5
	Current Rating	Up to 10A/Contact
	Voltage Rating	1p: 600 VAC 2p-5p: 300 VAC
	Operating Temp.	-40°C to +125°C
	Certifications	UL 1977 ROHS

INSULATION DISPLACEMENT TECHNOLOGY CONTINUED

	Low Profile (22-30 AWG) 9176-800	
	Application	Discrete Wire
	# of Positions	1 to 4
	Current Rating	Up to 7A/Contact
	Voltage Rating	1p: 600 VAC 2p-4p: 100 VAC
	Operating Temp.	-40°C to +125°C
	Certifications	UL 1977 ROHS

	Standard (14-20 AWG) 9177-000	
	Application	Discrete Wire
	# of Positions	1 to 3
	Current Rating	Up to 16A/Contact
	Voltage Rating	600 VAC
	Operating Temp.	-40°C to +125°C
	Certifications	UL 1059 ROHS

	Single (12-18 AWG) 9177-500	
	Application	Discrete Wire
	# of Positions	1
	Current Rating	Up to 15A/Contact
	Voltage Rating	600 VAC
	Operating Temp.	-40°C to +125°C
Certifications	UL 1977 ROHS	

	Single Thru Hole (12-18 AWG) 9177-600	
	Application	Discrete Wire
	# of Positions	1
	Current Rating	Up to 15A/Contact
	Voltage Rating	600 VAC
	Operating Temp.	-40°C to +125°C
	Certifications	UL 1977 ROHS

	Press-Fit / IDC (18-24 AWG) 53-8702	
	Application	Auto. Electronic Systems
	# of Positions	1 to 8
	Current Rating	Up to 10A
	Voltage Rating	125 VAC
	Operating Temp.	-40°C to +125°C
	Certifications	ROHS

POKE-HOME TECHNOLOGY

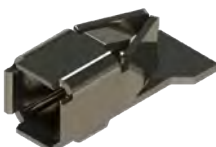
	Single Horizontal (12-28 AWG) 9296-000	
	Application	WTB
	# of Positions	1
	Current Rating	Up to 20A/Contact
	Voltage Rating	Dependent on Contact Spacing
	Operating Temp.	-40°C to +125°C
	Certifications	UL 1977 ROHS

	Micro Single Vertical (22-26 AWG) 9296-1X2	
	Application	WTB
	# of Positions	1
	Current Rating	Up to 8A/Contact
	Voltage Rating	Dependent on Contact Spacing
	Operating Temp.	-40°C to +125°C
	Certifications	UL 1977 ROHS

CONNECTOR SELECTOR

WIRE-TO-BOARD APPLICATIONS





POKE-HOME TECHNOLOGY CONTINUED

	Single Vertical (18-24 AWG) 9296-1X3	
	Application	WTB
	# of Positions	1
	Current Rating	Up to 15A/Contact
	Voltage Rating	Dependent on Contact Spacing
	Operating Temp.	-40°C to +125°C
	Certifications	UL 1977 ROHS

	Low Profile Horizontal (20-26 AWG) 9296-200	
	Application	WTB
	# of Positions	1 to 6
	Current Rating	Up to 8A/Contact
	Voltage Rating	300 VAC
	Operating Temp.	-40°C to +130°C
	Certifications	UL 1977 ROHS

	Horizontal (18-26 AWG) 9296-400	
	Application	WTB
	# of Positions	1
	Current Rating	Up to 10A/Contact
	Voltage Rating	600 VAC
	Operating Temp.	-40°C to +125°C
Certifications	UL 1977 ROHS	

	Inverted Thru Board (18-26 AWG) 9296-500	
	Application	Inverse WTB
	# of Positions	1 to 6
	Current Rating	Up to 7A/Contact
	Voltage Rating	600 VAC 1p 300 VAC 2p - 6p
	Operating Temp.	-40°C to +125°C
Certifications	UL 1977 ROHS	

	Vertical Top Entry (18-26 AWG) 9296-550	
	Application	WTB
	# of Positions	1 to 6
	Current Rating	Up to 7A/Contact
	Voltage Rating	600 VAC 1p 300 VAC 2p-6p
	Operating Temp.	-40°C to +125°C
Certifications	UL 1977 ROHS	

	Standard Vertical Top Entry (18-22 AWG) 9296-600	
	Application	WTB
	# of Positions	1
	Current Rating	Up to 8A
	Voltage Rating	600 VAC
	Operating Temp.	-40°C to +130°C
Certifications	UL 1977 ROHS	

	Standard Horizontal (18-26 AWG) 9276-000	
	Application	WTB
	# of Positions	1, 2, 3, 4, 6, 8
	Current Rating	Up to 6A/Contact
	Voltage Rating	300 VAC
	Operating Temp.	-40°C to +125°C
Certifications	UL 1977 ROHS	

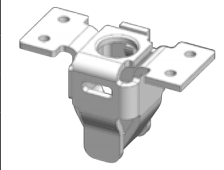
	Vertical Box Contact (12-18 AWG) 9296-11X	
	Application	WTB
	# of Positions	1
	Current Rating	Up to 20A/Contact
	Voltage Rating	Dependent on Con
	Operating Temp.	-40°C to +125°C
Certifications	UL 1977 ROHS	

2-PIECE CONNECTORS

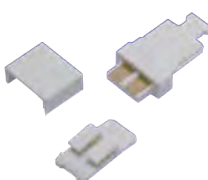
	Solder Cup Plug 11-9159-100	
	Application	Horizontal WTB with Latch
	# of Positions	2 to 6
	Current Rating	5A/Contact
	Voltage Rating	125 VAC
	Operating Temp.	-40°C to + 125°C
	Certifications	UL 1977 ROHS

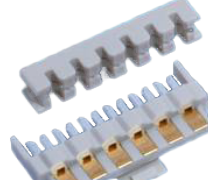
	Plug 14-9159-100	
	Application	Right Angle WTB with Latch
	# of Positions	2 to 6
	Current Rating	5A/Contact
	Voltage Rating	125 VAC
	Operating Temp.	-40°C to + 125°C
	Certifications	UL 1977 ROHS

	Socket 24-9159-100	
	Application	Right Angle WTB with Latch
	# of Positions	2 to 6
	Current Rating	5A/Contact
	Voltage Rating	125 VAC
	Operating Temp.	-40°C to + 125°C
	Certifications	UL 1977 ROHS

FINE-PITCH TECHNOLOGY

	1.27mm Pitch 8005 Series	
	Application	WTB
	# of Positions	2
	Current Rating	DC 1.0A
	Voltage Rating	DC 30V
	D.W. Voltage	AC 500Vrms
	Wire Size	AWG #32

	1.0mm Pitch 8040 Series	
	Application	WTB
	# of Positions	2
	Current Rating	DC 1.0A
	Voltage Rating	DC 30V
	D.W. Voltage	AC 500Vrms
	Wire Size	AWG #32



	0.9mm Pitch 8041 Series	
	Application	WTB
	# of Positions	2
	Current Rating	DC 1.0A
	Voltage Rating	DC 30V
	D.W. Voltage	AC 500Vrms
	Wire Size	AWG #32



CONNECTOR SELECTOR

WIRE-TO-WIRE APPLICATIONS





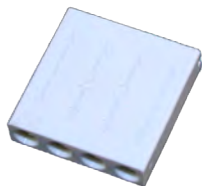

POKE-HOME TECHNOLOGY

 	Thru-Wire Connectors 9286-000	
	Application	Discrete Wire: 18-26 AWG
	# of Positions	1, 2, 3, 4, 6, 8
	Current Rating	Up to 8A/Contact
	Voltage Rating	300 VAC
	Operating Temp.	-40°C to +125°C
	Certifications	UL 1977 ROHS

 	Junction Box Connectors 9286-100	
	Application	Discrete Wire: 18-26 AWG
	# of Positions	4, 6, 8
	Current Rating	10A Total
	Voltage Rating	300 VAC
	Operating Temp.	-40°C to +125°C
	Certifications	UL 1977 ROHS

 	Reduced Thru Wire Connectors 9286-200	
	Application	Discrete Wire: 18-24 AWG
	# of Positions	1 to 6
	Current Rating	Up to 8A/Contact
	Voltage Rating	300 VAC
	Operating Temp.	-40°C to +130°C
	Certifications	UL 1977 ROHS

 	Reduced Junction Box Connectors 9286-250	
	Application	Discrete Wire: 18-24 AWG
	# of Positions	4, 6, 8
	Current Rating	Up to 8A/Contact
	Voltage Rating	300 VAC
	Operating Temp.	-40°C to +130°C
	Certifications	UL 1977 ROHS

 	Thru-Wire Connector 9286-300	
	Application	Discrete Wire: 12-18 AWG
	# of Positions	1
	Current Rating	Up to 15A/Contact
	Voltage Rating	600 VAC
	Operating Temp.	-40°C to +130°C
	Certifications	UL 1977 ROHS

BATTERY / COMPRESSION TECHNOLOGY

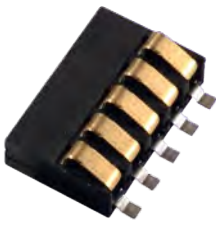
	Standard 2.5mm Pitch 9155-000	
	Application	Battery or BTB Connections
	# of Positions	3 to 5
	Current Rating	3A/Contact
	Voltage Rating	125 VAC
	Operating Temp.	-40°C to +125°C
	Certifications	ROHS

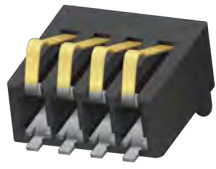
	Battery Connector 1.27mm Pitch 9155-020	
	Application	Battery or BTB
	# of Positions	2 to 5
	Current Rating	2p-3p: 3A/Contact 4p-5p: 2A/Contact
	Voltage Rating	400 VAC
	Operating Temp.	-40°C to +125°C
	Certifications	ROHS

	Ultra Low Profile 2.5mm Pitch 9155-100	
	Application	Battery or BTB Connections
	# of Positions	2 & 3
	Current Rating	3A/Contact
	Voltage Rating	125 VAC
	Operating Temp.	-40°C to +105°C
Certifications	ROHS	

	Battery Reduced 2.5mm Pitch 9155-200	
	Application	Battery or BTB Connections
	# of Positions	2 to 5
	Current Rating	3A/Contact
	Voltage Rating	125 VAC
	Operating Temp.	-40°C to +125°C
Certifications	ROHS	

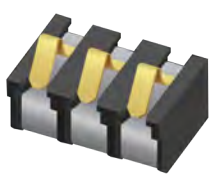
	Battery Reduced 2.5mm Pitch 9155-250	
	Application	Battery or BTB Connections
	# of Positions	2 to 5
	Current Rating	3A/Contact
	Voltage Rating	125 VAC
	Operating Temp.	-40°C to +125°C
Certifications	ROHS	

	Right Angle 3.0mm Pitch 9155-300	
	Application	Battery or BTB Connections
	# of Positions	2 to 6
	Current Rating	3A/Contact
	Voltage Rating	125 VAC
	Operating Temp.	-40°C to +105°C
Certifications	ROHS	

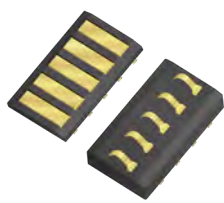
	Two Piece 4.0mm Pitch 9155-400	
	Application	Battery or BTB Connections
	# of Positions	2 to 6
	Current Rating	5A/Contact
	Voltage Rating	150 VAC
	Operating Temp.	-40°C to +125°C
Certifications	ROHS	

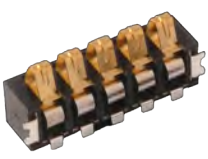
	Right Angle 2.5mm Pitch 9155-500	
	Application	Battery or BTB Connections
	# of Positions	2 to 5
	Current Rating	3A/Contact
	Voltage Rating	125 VAC
	Operating Temp.	-40°C to +125°C
Certifications	ROHS	

CONNECTOR SELECTOR

BOARD-TO-BOARD APPLICATIONS



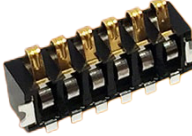

BATTERY / COMPRESSION TECHNOLOGY CONTINUED

	Low Profile Single Contact 9155-600	
	Application	BTB
	# of Positions	1
	Current Rating	3A/Contact
	Voltage Rating	300 VAC
	Operating Temp.	-40°C to +125°C
	Certifications	ROHS

	Right Angle 2.0mm Pitch 9155-700	
	Application	Battery or BTB
	# of Positions	2 to 6
	Current Rating	2p-4p: 2A 5p-6p: 1.5A
	Voltage Rating	125 VAC
	Operating Temp.	-40°C to +125°C
	Certifications	ROHS

	Vertical Mate 2.0mm Pitch 9155-800	
	Application	Battery or BTB
	# of Positions	2 to 8
	Current Rating	2-4p: 2A 5-6p: 1.5A
	Voltage Rating	125 VAC
	Operating Temp.	-40°C to +125°C
	Certifications	ROHS

	Dual Row Stacker 9158-000	
	Application	BTB
	# of Positions	16 to 32
	Current Rating	1A/Contact
	Voltage Rating	125 VAC
	Operating Temp.	-55°C to +125°C
	Certifications	ROHS

	Staggered Stacker 9188-000	
	Application	BTB
	# of Positions	4, 6, 8
	Current Rating	1A/Contact
	Voltage Rating	125VAC
	Operating Temp.	-55°C to +125°C
	Certifications	ROHS

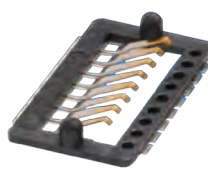
	Ultra Low Profile Stacker 9258-000	
	Application	BTB
	# of Positions	8
	Current Rating	1A/Contact
	Voltage Rating	125VAC
	Operating Temp.	-55°C to +125°C
	Certifications	ROHS

	Tall Stacker 9148-000	
	Application	BTB
	# of Positions	8
	Current Rating	1A Continuous
	Voltage Rating	125VAC
	Operating Temp.	-40°C to +125°C
	Certifications	ROHS

	Pogo Pin Single Contact 9150-000	
	Application	BTB
	# of Positions	1
	Current Rating	1A/Contact
	Voltage Rating	Dependent on Contact Distance
	Operating Temp.	-40°C to +125°C
	Certifications	ROHS

2-PIECE CONNECTORS

	Horizontal Plug 10-9159-100	
	Application	Linear BTB
	# of Positions	2 to 6
	Current Rating	5A/Contact
	Voltage Rating	125 VAC
	Operating Temp.	-40°C to +125°C
	Certifications	UL 1977 ROHS

	Vertical Plug 13-9159-100	
	Application	Perpendicular BTB
	# of Positions	2 to 6
	Current Rating	5A/Contact
	Voltage Rating	125 VAC
	Operating Temp.	-40°C to +125°C
	Certifications	UL 1977 ROHS

	Horizontal Socket 20-9159-100	
	Application	Linear BTB
	# of Positions	2 to 6
	Current Rating	5A/Contact
	Voltage Rating	125 VAC
	Operating Temp.	-40°C to +125°C
	Certifications	UL 1977 ROHS

	Top Load Socket 22-9159-100	
	Application	Linear BTB
	# of Positions	2 to 6
	Current Rating	5A/Contact
	Voltage Rating	125 VAC
	Operating Temp.	-40°C to +125°C
	Certifications	UL 1977 ROHS

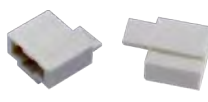
	Shorting Socket 58-9159	
	Application	Shorting Socket
	# of Positions	2
	Current Rating	5A/Contact
	Voltage Rating	125 VAC
	Operating Temp.	-40°C to +125°C
	Certifications	UL 1977 ROHS

	Linking Contact System 9159-300	
	Application	Linear BTB
	# of Positions	1
	Current Rating	9A/Contact
	Voltage Rating	300 VAC
	Operating Temp.	-40°C to +125°C
	Certifications	ROHS

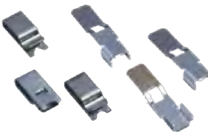
	Single 2-Piece Contacts 9159-400	
	Application	Linear BTB
	# of Positions	1
	Current Rating	5A/Contact
	Voltage Rating	300 VAC
	Operating Temp.	-40°C to +125°C
	Certifications	UL 1977 ROHS

CONNECTOR SELECTOR

BOARD-TO-BOARD APPLICATIONS





CARD-EDGE TECHNOLOGY

	Standard 9159-000	
	Application	Linear BTB
	# of Positions	2 to 5
	Current Rating	3A/Contact
	Voltage Rating	300 VAC
	Operating Temp.	-40°C to +125°C
	Certifications	UL 1977 ROHS

	Open-Ended 9159-060	
	Application	Linear BTB
	# of Positions	4, 6, 8, 10
	Current Rating	3.0 Amps 4p / 6p, 2.5 Amps 8p / 10p
	Voltage Rating	300 VAC
	Operating Temp.	-40°C to +125°C
	Certifications	UL 1977 ROHS

	Inverted Thru Board 9159-500	
	Application	Perpendicular BTB
	# of Positions	2 to 6
	Current Rating	2A/Contact
	Voltage Rating	300 VAC
	Operating Temp.	-40°C to +120°C
Certifications	UL 1977 ROHS	

	Vertical Top Entry 9159-550	
	Application	Perpendicular BTB
	# of Positions	2 to 6
	Current Rating	2A/Contact
	Voltage Rating	300 VAC
	Operating Temp.	-40°C to +120°C
Certifications	UL 1977 ROHS	

	Dual Row Inverted Thru Board 9159-600	
	Application	Perpendicular BTB
	# of Positions	4, 6, 8, 10, 12
	Current Rating	2.5A/Contact
	Voltage Rating	300 VAC
	Operating Temp.	-40°C to +125°C
Certifications	UL 1977 ROHS	



	Vertical Dual Row Top Entry 9159-650	
	Application	Perpendicular BTB
	# of Positions	4, 6, 8, 10, 12
	Current Rating	2.5A/Contact
	Voltage Rating	300 VAC
	Operating Temp.	-40°C to +125°C
Certifications	UL 1977 ROHS	



	Linear Card Edge with Springs 9159-7X0	
	Application	Linear BTB
	# of Positions	4, 6, 8, 10, 12
	Current Rating	Up to 2A/Contact
	Voltage Rating	150 VAC
	Operating Temp.	-40°C to +125°C
Certifications	UL 1977 ROHS	



	0.5mm Pitch 6411 Series	
	Type	H2.3 H3.2
	Pitch	0.5mm
	No. of Positions	67
	Current Rating	DC 0.4A
	Voltage Rating	DC 50V
	D.W. Voltage	AC 300 Vrms



*Compatible with the PCI-SIG, PCI Express® M.2 specifications

FINE-PITCH TECHNOLOGY

 	0.5mm Pitch 5652 Series	
	Stacking Height	15.0 to 25.0mm
	No. of Positions	60 to 180
	Current Rating	DC 0.6A DC 3A (Power Pin)
	Voltage Rating	DC 50V
	D.W. Voltage	AC 500 Vrms
	Floating	XY ± 0.85mm

 	0.5mm Pitch 5656 Series	
	Stacking Height	17.0 to 19.0mm
	No. of Positions	40 to 60
	Current Rating	DC 0.5A
	Voltage Rating	DC 50V
	D.W. Voltage	AC 250 Vrms
	Floating	XY ± 1.0mm

 	0.5mm Pitch 5655 Series	
	Stacking Height	4.0 to 7.0mm
	No. of Positions	40 to 100
	Current Rating	DC 0.7A DC 3A (Power Pin)
	Voltage Rating	DC 50V
	D.W. Voltage	AC 500 Vrms
	Floating	XY ± 0.5mm

 	0.4mm Pitch 8152 Series	
	Stacking Height	3.5mm
	Width	4.3mm
	No. of Positions	30
	Current Rating	DC 0.3A
	Voltage Rating	DC 30V
	D.W. Voltage	AC 250 Vrms
Floating	XY ± 0.4mm	

	0.5mm Pitch 5046 Series	
	Stacking Height	3.0 / 3.5 / 4.0 / 4.5mm
	Width	4.8mm
	No. of Positions	20 to 120
	Current Rating	AC/DC 0.4A
	Voltage Rating	AC/DC 50V
	D.W. Voltage	AC 500 Vrms

	0.5mm Pitch 5047 Series	
	Stacking Height	5.0 / 7.0mm
	Width	5.4mm
	No. of Positions	20 to 100
	Current Rating	AC/DC 0.4A
	Voltage Rating	AC/DC 50V
	D.W. Voltage	AC 500 Vrms

	0.4mm Pitch 5846 Series	
	Stacking Height	3.0mm
	Width	5.8mm
	No. of Positions	20 to 80
	Current Rating	DC 0.4A
	Voltage Rating	DC 50V
	D.W. Voltage	AC 250 Vrms

*FloXY® is a product brand of Kyocera's Floating Board to Board Connector series

CONNECTOR SELECTOR

BOARD-TO-BOARD APPLICATIONS



FINE-PITCH TECHNOLOGY CONTINUED

	0.4mm Pitch 5804 Series	
	Stacking Height	0.9 / 1.5 / 2.0mm
	Width	2.4mm
	No. of Positions	10 to 70
	Current Rating	DC 0.3A
	Voltage Rating	DC 50V
	D.W. Voltage	AC 250 Vrms

	0.4mm Pitch 5806 Series	
	Stacking Height	0.6mm
	No. of Positions	1.9mm
	Current Rating	10 to 30
	Voltage Rating	DC 0.3A
	D.W. Voltage	DC 60V
	Floating	AC 250 Vrms

	0.35mm Pitch 5843 Series	
	Stacking Height	0.8mm
	Width	2.4mm
	No. of Positions	12 to 48
	Current Rating	DC 0.3A
	Voltage Rating	DC 60V
D.W. Voltage	AC 250 Vrms	

 	0.35mm Pitch 5861 Series	
	Stacking Height	0.6mm
	Width	1.95mm
	No. of Positions	6 to 60
	Current Rating	DC 0.5A (~40 Pin) DC 0.3A (42 Pin~) DC 5.0A (Metal Tab)
	Voltage Rating	DC 60V
D.W. Voltage	AC 250 Vrms	

 	0.35mm Pitch 5863 Series	
	Stacking Height	0.8mm
	Width	2.3mm
	No. of Positions	50 to 60
	Current Rating	DC 0.3A DC 5.0A (Metal Tab)
	Voltage Rating	DC 60V
D.W. Voltage	AC 250 Vrms	

 	0.35mm Pitch 7129 Series	
	Stacking Height	0.7mm
	Width	2.2mm
	No. of Positions	2/4 (Signal) 4 (Power)
	Current Rating	DC 0.4A (Signal) DC 10A (2Power Cont.)
	Voltage Rating	DC 30V
D.W. Voltage	250 Vrms	

 	0.35mm Pitch 5897 Series	
	Stacking Height	0.8mm
	Width	2.3mm
	No. of Positions	78
	Current Rating	DC 0.3A DC 3.0A (Metal Tab)
	Voltage Rating	DC 50V
D.W. Voltage	AC 250 Vrms	

FINE-PITCH TECHNOLOGY

1.0mm Pitch 6232 Series (SMT)	
Profile Height	3.0mm (Right Angle) 5.1mm (Vertical)
No. of Positions	3 to 30
Current Rating	DC 0.5A
Voltage Rating	DC 50V
D.W. Voltage	AC 500 Vrms
FPC/FFC Thickness	0.3mm
Contact	Top, Bottom

1.0mm Pitch 6232 Series (DIP)	
Profile Height	3.0mm (Right Angle) 5.5mm (Vertical)
No. of Positions	3 to 30
Current Rating	DC 0.5A
Voltage Rating	DC 50V
D.W. Voltage	AC 500 Vrms
FPC/FFC Thickness	0.3mm
Contact	Single

0.5mm Pitch 6277 Series	
Profile Height	0.9mm
No. of Positions	3 to 6
Current Rating	DC 0.4A
Voltage Rating	DC 50V
D.W. Voltage	AC 200 Vrms
FPC/FFC Thickness	0.2mm
Contact	Dual

0.5mm Pitch 6298 Series	
Profile Height	0.9mm
No. of Positions	3 to 8
Current Rating	DC 0.4A
Voltage Rating	DC 50V
D.W. Voltage	AC 200 Vrms
FPC/FFC Thickness	0.2mm
Contact	Bottom

0.5mm Pitch 6809 Series	
Profile Height	0.93mm
No. of Positions	4 to 40
Current Rating	DC 0.5A
Voltage Rating	DC 50V
D.W. Voltage	AC 200 Vrms
FPC/FFC Thickness	0.3mm
Contact	Bottom

0.5mm Pitch 6811 Series	
Profile Height	1.28mm
No. of Positions	4 to 16
Current Rating	DC 0.5A
Voltage Rating	DC 50V
D.W. Voltage	AC 200 Vrms
FPC/FFC Thickness	0.3mm
Contact	Bottom

0.5mm Pitch 6284 Series	
Profile Height	1.5mm
No. of Positions	5 to 30
Current Rating	DC 0.4A
Voltage Rating	DC 50V
D.W. Voltage	AC 200 Vrms
FPC/FFC Thickness	0.3mm
Contact	Dual



0.5mm Pitch 6808 Series	
Profile Height	1.5mm
No. of Positions	7
Current Rating	DC 0.5A DC 4.0A (3 Contacts)
Voltage Rating	DC 50V
D.W. Voltage	AC 200 Vrms
FPC/FFC Thickness	0.3mm
Contact	Dual



CONNECTOR SELECTOR



FPC / FFC APPLICATIONS







FINE-PITCH TECHNOLOGY CONTINUED



 	0.5mm Pitch 6806 Series	
	Profile Height	1.75mm
	No. of Positions	8 to 80
	Current Rating	DC 0.5A
	Voltage Rating	DC 50V
	D.W. Voltage	AC 200 Vrms
	FPC/FFC Thickness	0.3mm
	Contact	Bottom

 	0.5mm Pitch 6815 Series	
	Profile Height	1.9mm
	No. of Positions	96 to 100
	Current Rating	DC 0.5A
	Voltage Rating	DC 50V
	D.W. Voltage	AC 200 Vrms
	FPC/FFC Thickness	0.3mm
	Contact	Bottom

 	0.5mm Pitch 6288 Series	
	Profile Height	2.0mm
	No. of Positions	8 to 80
	Current Rating	DC 0.4A
	Voltage Rating	DC 50V
	D.W. Voltage	AC 200 Vrms
	FPC/FFC Thickness	0.3mm
	Contact	Bottom

  	0.5mm Pitch 6892 Series	
	Profile Height	2.2mm
	No. of Positions	30 to 68
	Current Rating	DC 0.5A
	Voltage Rating	DC 50V
	D.W. Voltage	AC 200 Vrms
	FPC/FFC Thickness	0.3mm (Signal) 0.5mm (Sound)
	Contact	Bottom

 	0.5mm Pitch 6817 Series	
	Profile Height	2.6mm (Right Angle) 5.32mm (Vertical)
	No. of Positions	10 to 50
	Current Rating	DC 0.5A
	Voltage Rating	DC 50V
	D.W. Voltage	AC 200 Vrms
	FPC/FFC Thickness	0.3mm (Signal) 0.5mm (Ground)
	Contact	Bottom (Right Angle) Single (Vertical)

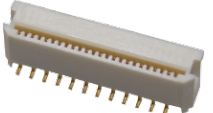

 	0.5mm Pitch 6810 Series	
	Profile Height	4.1mm (Right Angle) 6.0mm (Vertical)
	No. of Positions	10 to 60
	Current Rating	DC 0.4A
	Voltage Rating	DC 50V
	D.W. Voltage	AC 200 Vrms
	FPC/FFC Thickness	0.3mm (Signal) 0.5mm (Ground)
	Contact	Bottom (Right Angle) Single (Vertical)

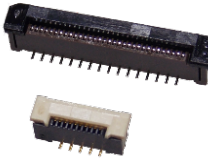

	0.5mm Pitch 6244 Series	
	Profile Height	4.1mm
	No. of Positions	6 to 30
	Current Rating	DC 0.4A
	Voltage Rating	DC 50V
	D.W. Voltage	AC 200 Vrms
	FPC/FFC Thickness	0.3mm
	Contact	Single

	0.5mm Pitch 6214 / 6274 Series	
	Profile Height	4.1mm (6214) 4.4mm (6274)
	No. of Positions	6 to 40 (6214) 31 to 50 (6274)
	Current Rating	DC 0.4A
	Voltage Rating	DC 50V
	D.W. Voltage	AC 200 Vrms
	FPC/FFC Thickness	0.3mm
	Contact	Single

"V-by-One" is registered trademarks of THine Electronics, Inc.

FINE-PITCH TECHNOLOGY CONTINUED

 	0.5mm Pitch 6251 Series	
	Profile Height	5.45mm
	No. of Positions	10 to 64
	Current Rating	DC 0.4A
	Voltage Rating	DC 50V
	D.W. Voltage	AC 200 Vrms
	FPC/FFC Thickness	0.3mm (Compatible with 6288)
	Contact	Single

 	0.5mm Pitch 6801 Series	
	Profile Height	5.5mm
	No. of Positions	20 to 50
	Current Rating	DC 0.4A
	Voltage Rating	DC 50V
	D.W. Voltage	AC 200 Vrms
	FPC/FFC Thickness	0.3mm (Compatible with 6288)
	Contact	Single

	0.4mm Pitch 6824 Series	
	Profile Height	0.93mm
	No. of Positions	4 to 22
	Current Rating	DC 0.4A
	Voltage Rating	DC 50V
	D.W. Voltage	AC 200 Vrms
	Contact	Dual

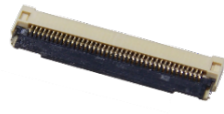
	0.4mm Pitch 6287 Series	
	Profile Height	1.2mm
	No. of Positions	14 to 76
	Current Rating	DC 0.4A
	Voltage Rating	DC 40V
	D.W. Voltage	AC 200 Vrms
	Contact	Bottom

	0.3mm Pitch 6293 Series	
	Profile Height	0.9mm
	No. of Positions	9 to 39
	Current Rating	DC 0.2A
	Voltage Rating	DC 50V
	D.W. Voltage	AC 250 Vrms
	Contact	Dual

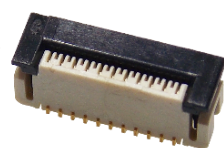
	0.3mm Pitch 6841 Series	
	Profile Height	3.6mm
	No. of Positions	15 to 51
	Current Rating	DC 0.2A
	Voltage Rating	DC 50V
	D.W. Voltage	AC 200 Vrms
	Contact	Single

	0.3mm Pitch 6844 Series	
	Profile Height	0.95mm
	No. of Positions	11 to 61
	Current Rating	DC 0.2A
	Voltage Rating	DC 50V
	D.W. Voltage	AC 200 Vrms
	Contact	Bottom

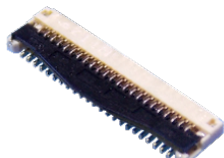
	0.3mm Pitch 6866 Series	
	Profile Height	0.95mm
	No. of Positions	21 to 71
	Current Rating	DC 0.2A
	Voltage Rating	DC 50V
	D.W. Voltage	AC 200 Vrms
	Contact	Bottom

CONNECTOR SELECTOR

SPECIALTY APPLICATIONS





SINGLE PAIR ETHERNET

	Jack/Receptacle SPE IP20 6780 Series	
	Application	Industrial Ethernet
	# of Positions	2
	Current Rating	4A
	Voltage Rating	60 VDC
	Operating Temp.	-40°C to +85°C
	Certifications	IEC 63171-6

	Plug Cable Assembly SPE IP20 6780 Series	
	Application	Industrial Ethernet
	# of Positions	2
	Current Rating	4A
	Voltage Rating	60 VAC
	Operating Temp.	-40°C to +85°C
	Certifications	IEC 63171-6

INPUT/OUTPUT

	Standard I/O 15P 9157-015	
	Application	Portable Devices: Industrial/Medical
	# of Positions	15
	Current Rating	Up to 1.5A/Contact
	Voltage Rating	125 VAC
	Operating Temp.	-55°C to +125°C
	Certifications	ROHS

	Reduced Size 9257-000	
	Application	Portable Devices: Industrial/Medical
	# of Positions	16
	Current Rating	Up to 1A/Contact
	Voltage Rating	125 VAC
	Operating Temp.	-55°C to +85°C
	Certifications	ROHS

	Standard I/O 19P 9157-019	
	Application	Portable Devices: Industrial/Medical
	# of Positions	19
	Current Rating	Up to 1.5A/Contact
	Voltage Rating	125 VAC
	Operating Temp.	-55°C to +125°C
	Certifications	ROHS

	Mini 9257-100	
	Application	Portable Devices: Industrial/Medical
	# of Positions	12
	Current Rating	Up to 1.5A/Contact
	Voltage Rating	50 VAC
	Operating Temp.	55°C to +85°C
	Certifications	ROHS

MEMORY PRODUCTS

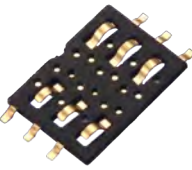
	SIM Block 9162-000	
	Application	Cellular Phones / Radios
	# of Positions	6
	Current Rating	Up to 0.5A/Contact
	Voltage Rating	50 VAC
	Operating Temp.	-55°C to +80°C
	Certifications	ROHS

	Slide-In SIM 9162-200	
	Application	Cellular Phones / Radios
	# of Positions	6
	Current Rating	Up to 0.5A/Contact
	Voltage Rating	50 VAC
	Operating Temp.	-55°C to +105°C
	Certifications	ROHS

	Locking SIM 9162-300	
	Application	Cellular Phones / Radios
	# of Positions	6
	Current Rating	Up to 0.3A/Contact
	Voltage Rating	30 VAC
	Operating Temp.	-55°C to +125°C
Certifications	ROHS	

	Slide-In Low Profile SIM 9162-400	
	Application	Cellular Phones / Radios
	# of Positions	6
	Current Rating	Up to 0.5A/Contact
	Voltage Rating	15 VAC
	Operating Temp.	-55°C to +70°C
Certifications	ROHS	

	SIM/Micro SD Combination 9162-500	
	Application	Cellular Phones / Radios
	# of Positions	6
	Current Rating	Up to 0.3A/Contact
	Voltage Rating	15 VAC
	Operating Temp.	-55°C to +70°C
Certifications	ROHS	

CONNECTOR SELECTOR

SPECIALTY APPLICATIONS



POWER TERMINALS

	9069 Series	
	No. of Positions	6 / 8 / 10
	Pitch	3.18mm (6pos.) 2.54mm (8, 10pos.)
	Current Rating	AC/DC 18A (6pos.) AC/DC 24A (8pos.) AC/DC 30A (10pos.)
	Application Screw	M4

SHIELD LOCKS

	8069 Series	
	Stacking Height	1.8 / 3.0mm
	Current Rating	AC/DC 0.5A
	Voltage Rating	AC/DC 5A
	Thickness	0.2mm

BRANCH CONNECTORS

	Branch Connector 9215 Series	
	Current	Aluminum Wire: AC/DC 9.0A Copper Wire: AC/DC 3.0A (0.13sq) AC/DC 8.0A (0.3sq) AC/DC 10.0A (0.5/0.85sq)
	Voltage	AC/DC 125V
	D.W. Voltage	AC 1,000 Vrms
	Wire Size	Aluminum Wire: 0.5/0.75sq Copper Wire: 0.13/0.3/0.5/0.85sq

	Branch Connector 9715 Series	
	Current	Aluminum Wire: AC/DC 8.0A (0.5sq) AC/DC 9.0A (0.75sq) Copper Wire: AC/DC 9.0A (0.5sq)
	Voltage	AC/DC 125V
	D.W. Voltage	AC 1,000 Vrms
	Wire Size	Aluminum Wire: 0.5/0.75sq Copper Wire: 0.5sq

STAY CONNECTED!

Tools Available Online:



**DATASHEETS
& CATALOGS**



3D MODELS



VIDEOS



**APPLICATION
& PRODUCT
GUIDE**



**PART
NUMBER
INFORMATION**



NORTH AMERICA
Tel: +1-864-967-2150

CENTRAL AMERICA
Tel: +55-11-46881960

EUROPE
Tel: +44-1276-697000

ASEAN / INDIA / TAIWAN
Tel: +65-6271-0500

CHINA
Tel: +86-21-5877-5366 *511

JAPAN
Tel: +81-75-604-3640

KOREA
Tel: +82-2-3463-3538

 WWW.KYOCERA-AVX.COM

