

JST Products for Battery Connections

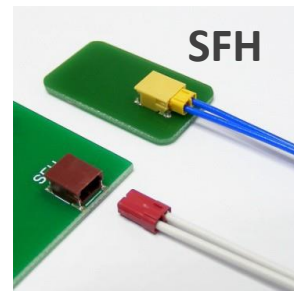
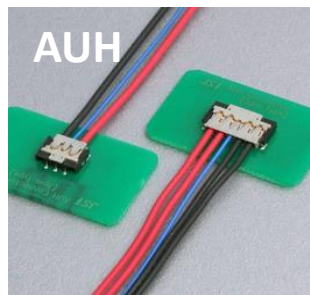
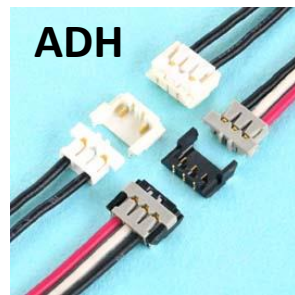
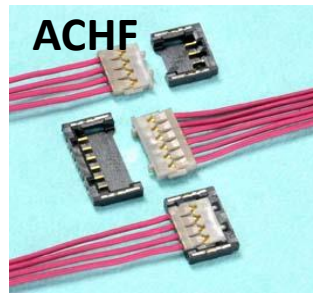
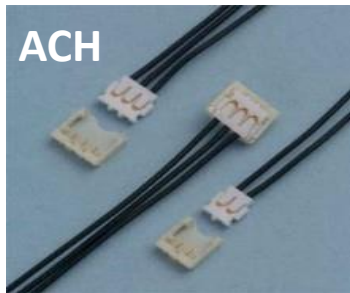

Table of Contents

Series Name	Pitch	No. of Circuits	Current Rating*	Voltage Rating	AWG Range	BtB	WtB	WtW
ACH	1.2 mm	1, 2, 3, 4	2A 1.5A	50V AC/DC	AWG 30-28		X	X
ACHF	1.2mm	3, 4, 6	1.0A (signal) 2.5A (power)	50V	AWG 30-28		X	
ACHL	1.2mm	2	2.0A	50V	AWG 30-28		X	
ADH	1.3	3	3.0A	30V	AWG 28-26		X	
AUH	1.85 mm	3 + 5	1.0A (signal) 5.0A (power)	30V AC/DC	AWG 30-22		X	
SFH	1.8 mm	2	4.0A	350V AC/DC	AWG 30-22		X	

* depends on wire range / circuit no.

JST Sales America

1957 South Lakeside Dr.
Waukegan, IL 60085

Tel: 800-947-1110
Fax: 847-473-0144

E-mail: TAC@jst.com Internet:
www.jst.com

AUH Connector

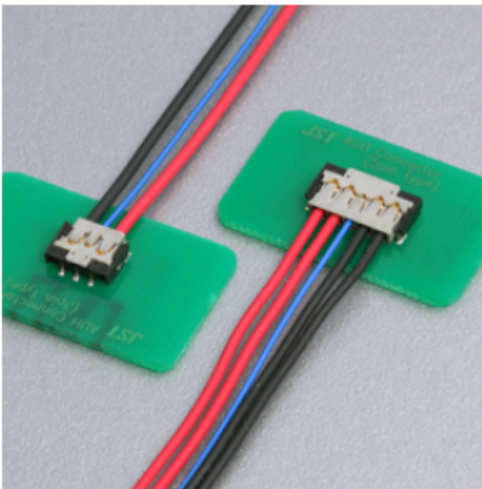

This AUH connector is compact and low profile type, height 1.85mm and width 5.2mm, wire-to-board connector. And also 5A in rating current was realized.

Product Profile

Series	AUH Connector
Category	Wire to Board Crimp style Connectors
Type	Crimp style, Disconnectable type Crimp style, Compact type, Low-profile type
Feature	Low-profile

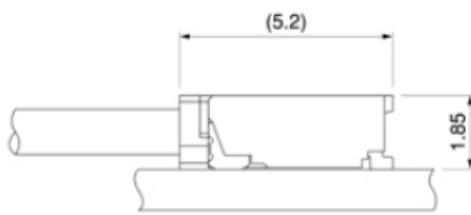

Specification

Current rating	Power supply circuit/5A (AWG#22) Signal circuit/1A
Voltage rating	30V

Compliant with RoHS.

(LF)(SN) as identification part number shall be displayed on a label.

When ordering RoHS compliant products, please inquire to the nearest JST Sales Office, or order them with the described part number adding (LF)(SN) as the identification marking after it.



JST Sales America

1957 South Lakeside Dr.
Waukegan, IL 60085
Tel: 800-947-1110
Fax: 847-473-0-144

Email: Tac@jst.com

Website: www.jst.com

ADH Connector



This ADH connector is compact and low profile type, height 1.9mm and width 4.3mm, 1.3 pitch wire-to-board connector.

Product Profile

Series	ADH Connector
Category	Wire to Board Crimp style Connectors
Type	Crimp style, Disconnectable type Crimp style, Compact type, Low-profile type
Feature	Low-profile

Specification

Pitch	1.3 mm
Current rating	3A (AWG#26)
Voltage rating	30V

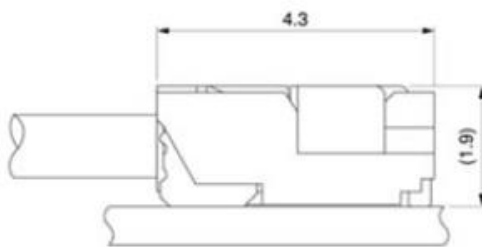

Compliant with RoHS.

(LF)(SN) as identification part number shall be displayed on a label. When ordering RoHS compliant products, please inquire to the nearest JST Sales Office, or order them with the described part number adding (LF)(SN) as the identification marking after it.



JST Sales America

1957 South Lakeside Dr.
Waukegan, IL 60085
Tel: 800-947-1110
Fax: 847-473-0-144

Email: Tac@jst.com

Website: www.jst.com

ACHL connector



This connector is compact and low profile type, height 1.2mm and width 4.7mm, 1.2mm pitch wire-to-board connector.

Product Profile

Series	ACHL connector
Category	Wire to Board Crimp style Connectors
Type	Disconnectable type Crimp style, Compact type, Low-profile type
Feature	Low-profile

Specification

Pitch	1.2 mm
Current rating	2A (AWG#28)
Voltage rating	50V

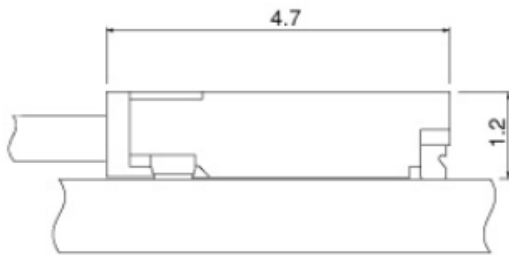

Compliant with RoHS.

(LF)(SN) as identification part number shall be displayed on a label.

When ordering RoHS compliant products, please inquire to the nearest JST Sales Office, or order them with the described part number adding (LF)(SN) as the identification marking after it.



JST Sales America

1957 South Lakeside Dr.
Waukegan, IL 60085
Tel: 800-947-1110
Fax: 847-473-0-144

Email: Tac@jst.com

Website: www.jst.com

ACHF Connector

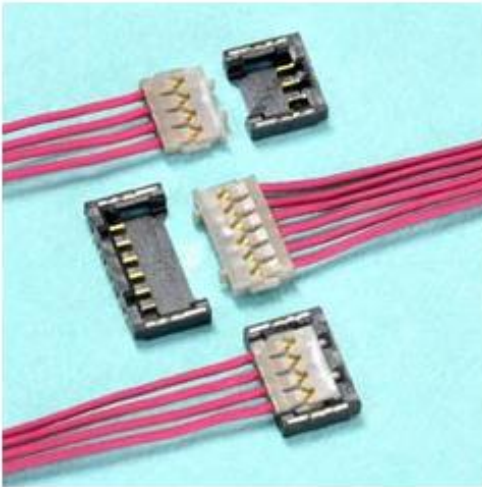

This ACHF connector is compact and low profile type, height 1.43mm and width 4.95mm, 1.2 pitch wire-to-board connector.

Product Profile

Series	ACHF Connector
Category	Wire to Board Crimp style Connectors
Type	Crimp style, Disconnectable type Crimp style, Compact type, Low-profile type
Feature	Low-profile

Specification

Pitch	1.2 mm
Current rating	2.5A (AWG#28)
Voltage rating	50V

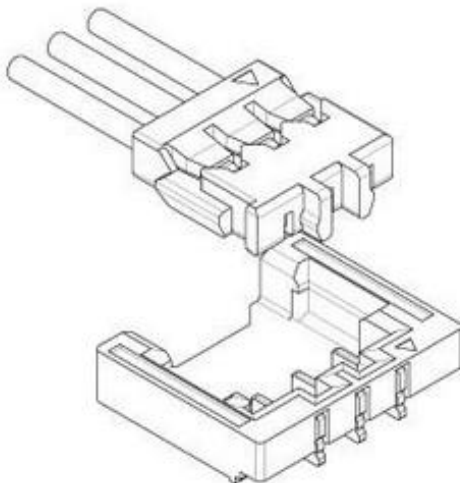

Compliant with RoHS.

(LF)(SN) as identification part number shall be displayed on a label.

When ordering RoHS compliant products, please inquire to the nearest JST Sales Office, or order them with the described part number adding (LF)(SN) as the identification marking after it.



JST Sales America

1957 South Lakeside Dr.
Waukegan, IL 60085
Tel: 800-947-1110
Fax: 847-473-0-144

Email: Tac@jst.com

Website: www.jst.com

ACH connector

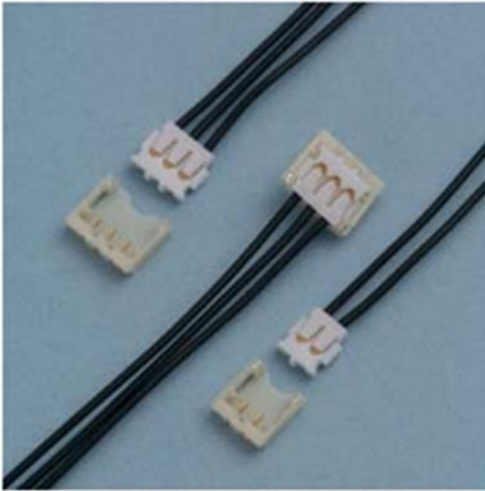

This connector is compact and low profile type, height: 1.4mm and width 4.3mm, 1.2mm pitch wire-to-board connector.

Product Profile

Series	ACH connector
Category	Wire to Board Crimp style Connectors
Type	Disconnectable type Crimp style, Compact type, Low-profile type
Feature	For LED lamp

Specification

Pitch	1.2 mm
Current rating	2A/1to3-circuit (AWG#28) 1.5A/4-circuit (AWG#28)
Voltage rating	50V
PC board mounting direction	Top entry

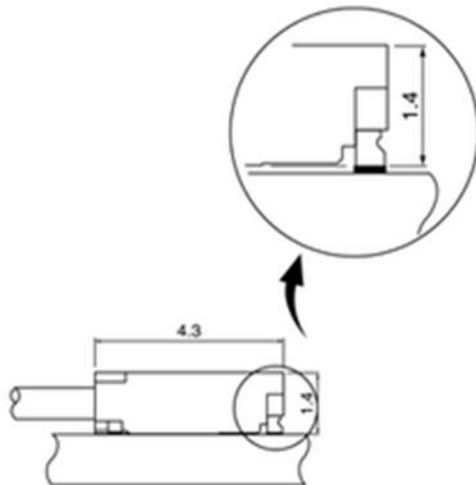

Compliant with RoHS.

(LF)(SN) as identification part number shall be displayed on a label. When ordering RoHS compliant products, please inquire to the nearest JST Sales Office, or order them with the described part number adding (LF)(SN) as the identification marking after it.



JST Sales America

1957 South Lakeside Dr.
Waukegan, IL 60085
Tel: 800-947-1110
Fax: 847-473-0-144

Email: Tac@jst.com

Website: www.jst.com

SFH connector

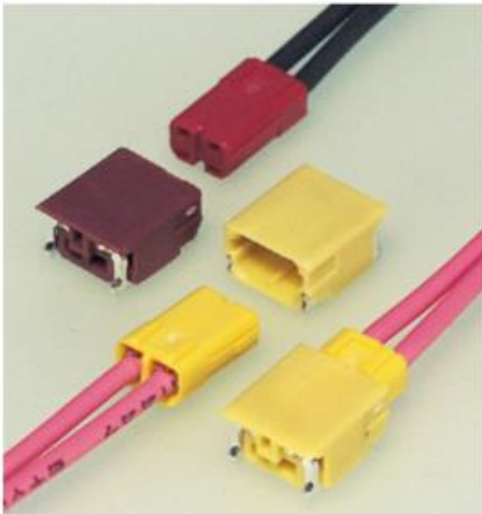

This low profile type connector with height of 3.0mm is designed for connection to stroboscope flash and realized space saving.

Product Profile

Series	SFH connector
Category	Wire to Board Crimp style Connectors
Type	Disconnectable type Crimp style, Compact type, Low-profile type
Feature	High withstanding voltage

Specification

Pitch	1.8 mm
Current rating	4A (AWG#22)
Voltage rating	350V
PC board mounting direction	Side entry

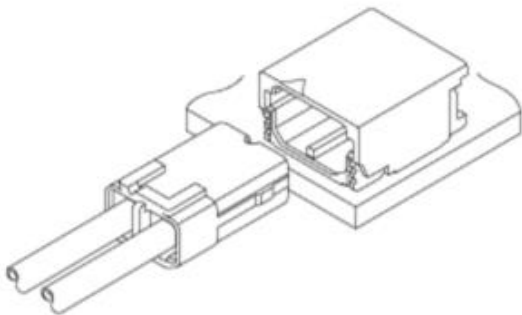

JST Sales America

1957 South Lakeside Dr.
Waukegan, IL 60085
Tel: 800-947-1110
Fax: 847-473-0-144

Email: Tac@jst.com

Website: www.jst.com