



Power Management Solution: Constant Voltage (CV) Pulse Charging of Hybrid Capacitors

By Gerald Tatschl

ENYCAP™ 196 HVC SERIES

GENERAL INFORMATION

Rechargeable energy storage solutions are of high interest because of their flexibility, low maintenance requirements, and reduced cost over their life-cycle.

For compact applications, classic electrolytic capacitors are environmentally friendly alternatives and available for a wide range of rated voltages. However, they soon reach their energy storage limit with output requirements exceeding a few 100 mWs.

Electric double-layer capacitors (EDLC) offer high power and energy density, as well as long working life, but are limited to low working voltages in the same range as batteries. Electronic systems require a compromise between these technologies, namely solutions that combine the advantages of classic batteries and double-layer capacitors without the limitations. Hybrid - ENYCAP™ 196 HVC - capacitors can deliver this performance. In order to fully utilize the product performance, a reliable charging solution must be applied. This document proposes constant voltage (CV) pulse charging as the most cost-efficient solution.

HYBRID CAPACITOR TECHNOLOGY AND PROPERTIES

Hybrid systems combine electrostatic and faradaic energy storage. Therefore, faster charging than a battery is possible. Hybrid capacitor systems easily surpass the power density of batteries and have significantly higher energy density than double-layer capacitors.

Due to the faradaic energy storage component, hybrid capacitors have a limited and narrow operating voltage range, similar to batteries. While this voltage stability is beneficial in many applications, capacitor voltage and current have to be carefully managed in order to maintain optimum performance over a long operational life.

The maximum cell voltage must not be exceeded. Consequently, for an optimum lifespan, power management has to safeguard the operation limits with absolute accuracy in the mV range.

It also has to be taken into account that the current flow through hybrid capacitors is partly related to faradaic conversion processes. As these processes require some time, the maximum permissible currents have to be maintained for charging and discharging.

Self-discharge of hybrid capacitors is significantly lower than for EDLCs. For example, self discharge is below 5 % / day for the ENYCAP 196 HVC.

As faradaic storage processes always include some material conversion, it is evident that overcharging must be avoided. Even if the ENYCAP 196 HVC has some short time tolerance in this aspect, it has to be considered that over long periods of time, without proper control measures, even low charge currents can overcharge the capacitor.

The cycle life performance of hybrid capacitors is superior to batteries. For example, the ENYCAP 196 HVC can achieve more than 50 000 cycles.

GENERAL INFORMATION ON CV PULSED CHARGING

For applications requiring a constantly high charge state of the energy storage device, such as backup systems, a CV pulsed charging method (PCM) is recommended. The PCM can be implemented in a rather simple power management environment and will ensure the safe operation of the hybrid storage component within recommended limits and conditions.

Pulsed charging is the preferred method for compensating self-discharge while avoiding regular or permanent overcharging. This can largely improve the lifetime of the energy storage system.

Power Management Solution: Constant Voltage (CV) Pulse Charging of Hybrid Capacitors

Pulsed or intermittent charging can be implemented with a constant voltage source controlled by a timer. The voltage source has to be accurately adjusted to the charging voltage of the storage system.

There are five steps to a typical operation sequence (see Fig. 4):

1. An initial charge step ensures sufficient energy for the next backup operation (load)
2. Check for available energy by testing the open circuit voltage (OCV) of the storage element
3. Monitor state of health (SOH)
4. Apply a charge pulse to compensate self-discharge and backup load
5. Restart at step 2

Note

- Steps 2 to 5 compensate self-discharge effects and keep storage elements by this kind of **trickle charging** in healthy condition, also over extended long periods of time.

NOMINAL VOLTAGE

ENYCAP 196 HVC storage capacitors are manufactured as a stack of one or more individual cells. Each cell has a rated voltage U_R of 1.4 V.

Therefore, each hybrid storage capacitor is a configuration of X cells in series and has a rated voltage U_R of $X * 1.4$ V.

CV CHARGING

CV PULSED CHARGING

CV charging is defined by the application of a constant voltage UCV_{charge} on the terminals of the storage device. For the CV PCM, the charging time is additionally limited by a switch SW1, which is controlled by proper algorithms.

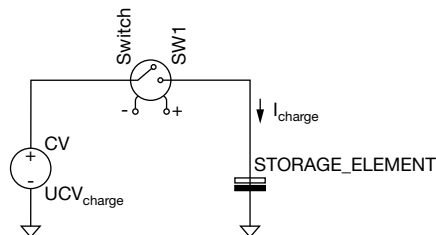

For considered systems and voltages, the resulting charging current I_{charge} is dependent on the state of charge (SOC) of the storage element. The lower the SOC, the higher the current I_{charge} in general.

In correspondence with the well-known Ohm's law, the following can be stated:

1. The lower the SOC, the higher the current I_{charge}
2. The higher the applied voltage UCV_{charge} , the higher the current I_{charge}

As a consequence of 1, the charging current decreases with a higher SOC. This effect is undesired, because due to a reduced charging current the charging time will be extended. According to statement 2, an increase of UCV_{charge} will increase the current I_{charge} too and would finally allow a shorter charging time.

However, elevated UCV_{charge} will lead to high residual charging current as long as source voltage is applied. It has to be ensured that the system is not overcharged unnecessarily when it is fully charged.

Constraints

All types of storage elements require that the following parameters remain within specified limits:

- Maximum and minimum charging voltage
- Maximum charging current
- SOC: overcharge as integral $Q = \int I_{charge} * dt$ has to be limited
- Temperature

Power Management Solution: Constant Voltage (CV) Pulse Charging of Hybrid Capacitors

CHARGING CURRENT

$Q = \int I_{\text{charge}} * dt$ should be limited to avoid overcharging (> 100 % SOC). This fact supports the idea of a timer-controlled intermittent or PCM. This procedure also restricts negative impacts of very low residual charge currents over extended time periods and ensures optimum lifetime of the product.

The amount of energy to be charged can be controlled by the “ON Time” of the charging source. Necessary charge $Q = \int I_{\text{charge}} * dt$ has to be selected according to product specifications.

Maximum charge current is usually defined by type and size of the storage element.

For ENYCAP the following parameters are applicable:

TABLE 1 - MAXIMUM CHARGE CURRENT		
196 HVC 4 F	196 HVC 15 F	196 HVC 90 F
14 mA	40 mA	1.5 A

The safe area for the increase of UCV_{charge} is considered and listed in section “Charging Voltage,” Table 2.

CHARGING VOLTAGE (WITH TEMPERATURE COMPENSATION)

The correct charging voltage is temperature-dependent (see Fig. 1).

There are two reasons that temperature impacts charging voltage:

1. Dynamics of electrochemical reactions depend on temperature
2. Internal resistances of the cell vary with temperature

The two effects result in a linear voltage dependency of -1 mV / 1 °C per cell.

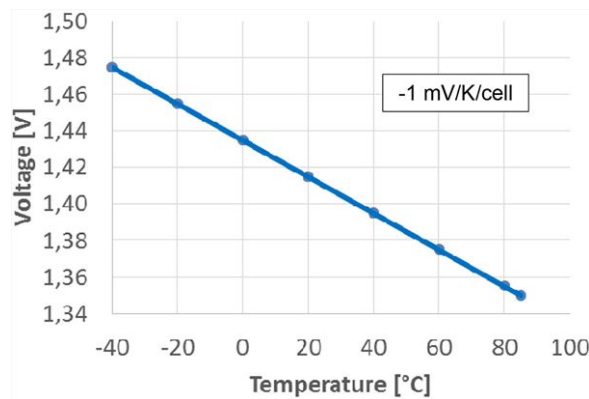

Fig. 1 - Charging voltage as a function of temperature

The correct charging voltage for the standard configuration at 20 °C is shown in Table 2.

TABLE 2 - CONSTANT VOLTAGE SETTING FOR 20 °C (ENYCAP 196 HVC)		
RATED VOLTAGE (V)	VOLTAGE $CV_{\text{CHARGE}} 20\text{ °C}$ (V)	VOLTAGE FAST $CV_{\text{CHARGE}} 20\text{ °C}$ (V)
1.4	1.42	1.45
2.8	2.84	2.90
4.2	4.26	4.35
5.6	5.68	5.80
7.0	7.10	7.25
8.4	8.52	8.70

Temperature compensation of the charging voltage is an advantage to ensure fully functional operation over a wide temperature range. However, it is not mandatory for every application (see next section).

Power Management Solution: Constant Voltage (CV) Pulse Charging of Hybrid Capacitors

CHARGING VOLTAGE (WITHOUT TEMPERATURE COMPENSATION)

ENYCAP 196 HVC hybrid storage capacitors can also be charged without proper temperature compensation. In these cases some restrictions should be respected in order to improve lifetime if a very wide temperature range has to be covered.

If the charging voltage is not adjustable at all, charging should only be allowed up to a certain upper voltage and temperature limit; typically 1.4 V per cell up to 60 °C can be used (Fig. 2).

Charging with this fixed voltage at lower temperatures will not damage the cell. But at lower temperatures recharge efficiency is reduced and the hybrid capacitors cannot be fully charged.

Fig. 2 shows the limitations if a charging voltage of only 1.4 V per cell is available.

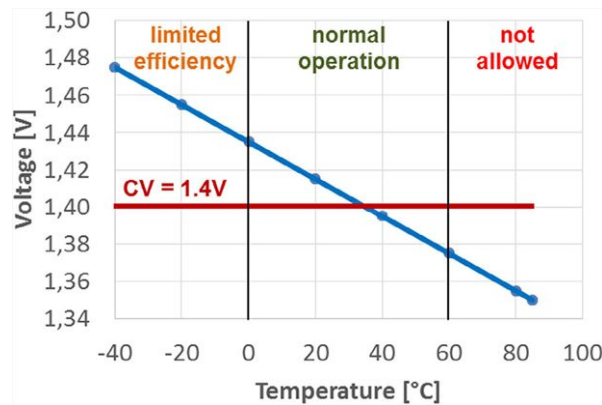

Fig. 2 - Charging with 1.40 V per cell over temperature range

If two or three different charging voltages are available, stepwise approximation over the whole temperature range is possible (see Fig. 3).

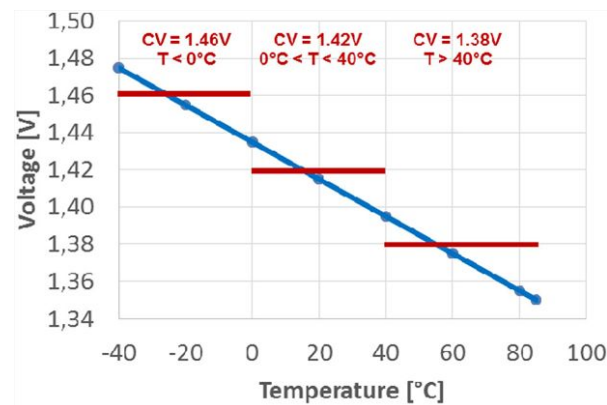

Fig. 3 - Stepwise approximation with three voltage levels

Power Management Solution: Constant Voltage (CV) Pulse Charging of Hybrid Capacitors

PCM FLOW CHART

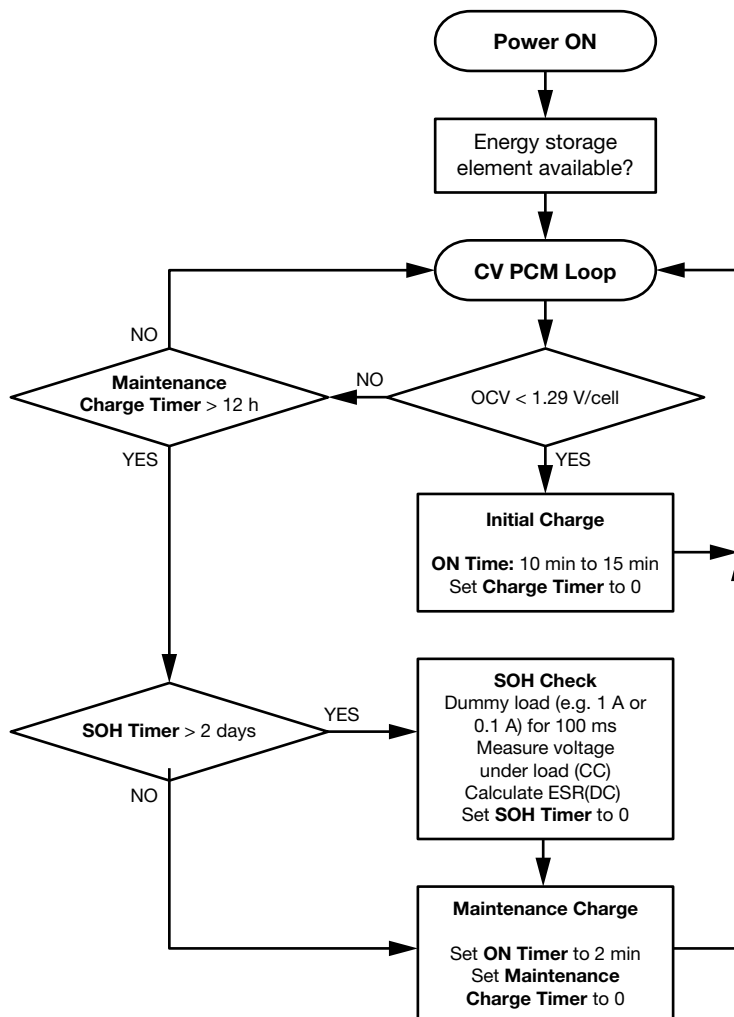

Fig. 4 - Flow chart for operation of a backup system with pulsed charging

OCV CHECK

The open circuit voltage (OCV) has to be measured periodically. If the OCV is below 1.29 V per cell, an initial charge cycle has to be applied (see Fig. 1).

One measurement per second is sufficient. Depending on the circuitry, more measurements could create additional leakage current, which should be avoided.

NORMAL OPERATION / MAINTENANCE CHARGE

Short charge pulses, typically 1 minute to 3 minutes in duration every ~ 6 h to 12 h, will keep the hybrid capacitors charged and will compensate self discharge (for typical properties see Fig. 5 and the example in Fig. 6).

The most simple way to control both maintenance charge and the amount of energy to be recharged can be a timer. After each charge pulse the OCV will relax during the “Source OFF” phase.

Power Management Solution: Constant Voltage (CV) Pulse Charging of Hybrid Capacitors

This pulsed or intermittent charging mode is possible because ENYCAP 196 HVC hybrid capacitors have superior charge retention (low self-discharge rate) compared to conventional EDLC's.

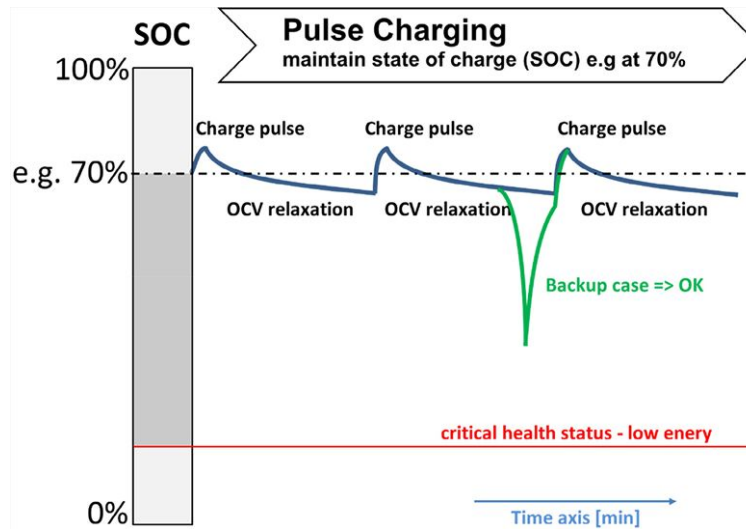

Fig. 5 - Typical maintenance charge over time - charge pulses keep SOC on a defined high level. OVC relaxation is dependent on the load situation and self-discharge. For a typical backup, SOC has to be high enough to supply the required energy.

In relation to total operating time, very short charging periods increase efficiency in the charging process and minimize the total amount of overcharge.

Intermittent or pulse charging uses these benefits to maximize the lifetime of the storage element.

An SOC above 70 % is sufficient to supply the application with the rated and specified amount of energy. For a single cell it is 115 J / HVC 90 F, 17.5 J / HVC 15 F, and 4.1 J / HVC 4 F.

The maximum lifetime, cycle stability, and fast charge capability can be maintained with this amount of useable energy.

The example in Fig. 6 is a 196 HVC 90 F 4.2 V, which is in maintenance charge mode for 25 days (at 45 °C). The maintenance charge pulses keep the hybrid storage element fully charged and compensates for self-discharge.

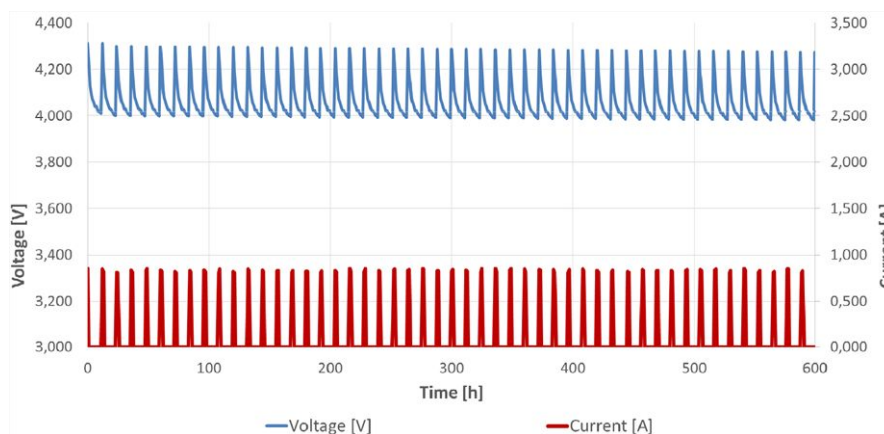

Fig. 6 - 196 HVC 90 F maintenance charge 1 minute every 12 hours at 45 °C

Power Management Solution: Constant Voltage (CV) Pulse Charging of Hybrid Capacitors

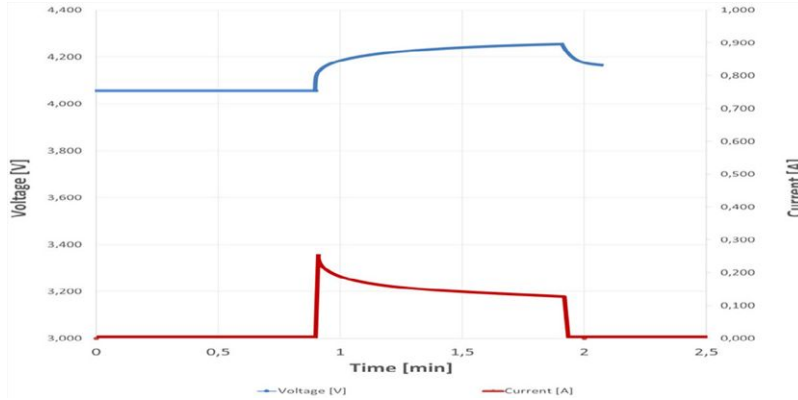

Fig. 6a - First maintenance charge pulse (1 minute) after 6 h (example 90 F 4.2 V)

A recharge of 5 % per day is sufficient and will not age the hybrid capacitors by overcharging. Additional leakage currents might occur and have to be considered.

Proper recharge is recommended if the voltage drops below 1.29 V per cell in order to bring the SOC back to the intended level quickly. This can be achieved by simply applying an additional “initial charge” cycle (see section “Initial Charge”). This voltage-triggered recharge is a safety feature to ensure a sufficiently high SOC.

The voltage value of 1.29 V is independent of temperature.

An example for a state with OCV voltage below 1.29 V could be increased self-discharge at an unintended high temperature.

INITIAL CHARGE

Initial charge is necessary if more than 5 % of the nominal energy has to be recharged. The “ON Time” of 5 minutes to 15 minutes in the flow chart in Fig. 4 is a typical range for CV charging. It depends on the required energy of the application.

The initial charge will recharge the hybrid capacitor sufficiently for the next use. If significantly less energy than the specified 115 J per cell (for example, a 90 F cell) is required, the “ON Time” can be reduced.

An initial charge is most likely necessary after a backup case or after system power-off periods for several days or weeks.

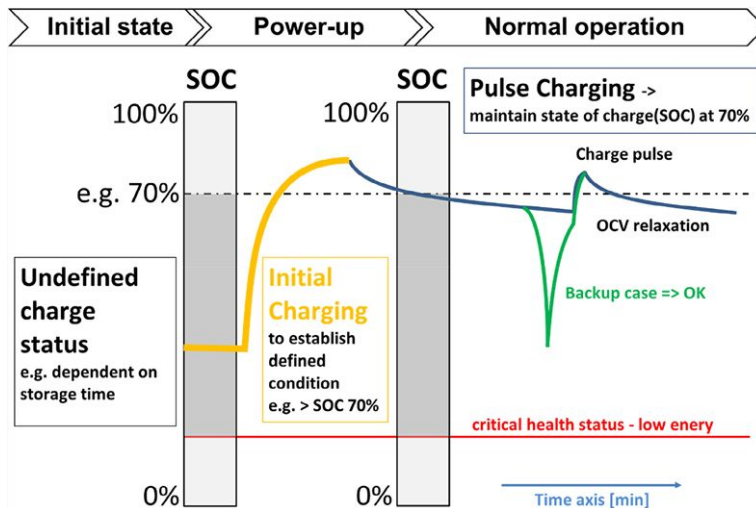

Fig. 7 - Typical power-up and normal operation cycles. Initial charging is necessary in order to establish the desired SOC level for normal operation.

Power Management Solution: Constant Voltage (CV) Pulse Charging of Hybrid Capacitors

An initial charge cycle is also recommended if the system is turned on for the first time after shelf storage. In this case the first charge step is also called the “conditioning” charge. After a prolonged storage time, the hybrid storage element might be in an undefined SOC. So it is important to recharge it in a first step.

The example in Fig. 8 shows the initial charge of a HVC 90 F 4.2 V system in fast charge mode. Enough energy is recharged for the next backup within 5 minutes, without overcharging. Because of the good charge retention it is possible to wait for several hours before recharging again with short maintenance charge pulses.

The “ON Time” of 15 minutes is a typical example. “ON Time” has to be long enough to sufficiently charge the ENYCAP 196 HVC storage system for the forthcoming operation cycle (e.g. backup).

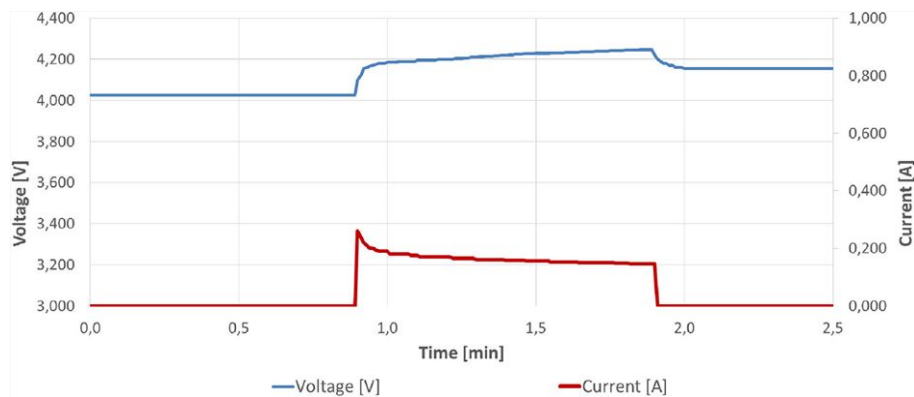

Fig. 8 - The first 15 minutes of initial charge (example 90 F, 4.2 V)

SUMMARY

Intermittent charging by a simple timer-controlled CV method is recommended for best performance and long service life of ENYCAP 196 HVC hybrid capacitors.

The aim is to constantly maintain a high SOC in order to be ready for a backup event, while minimizing unnecessary overcharge. After a backup scenario, the storage elements can be recharged quickly due to the innovative hybrid cell chemistry. ENYCAP 196 HVC capacitors are the ideal solution if more energy is required for reliable backup applications.

REFERENCES

1. Datasheet ENYCAP 196 HVC Series
www.vishay.com/doc?28409
2. Vishay ENYCAP technical note “CV Pulse Charging”
www.vishay.com/doc?28428
3. This document