

Precaution for Crimping Process

The following instructions describe the procedure to be adopted when crimping terminals or contacts onto wires. Please read the relevant connector and application tooling “Handling Manuals” prior to terminating the connector. If you need any further information, please contact JST.

1. Crimping tools

When JST chain terminals are crimped or terminated with wires, always use application tooling specified by JST. If this process is conducted using application tooling other than that specified, product defect and failure may occur. JST cannot accept any liability for failures due to the use of non-JST application tooling.

2. Applicable wires

Before starting the crimping process, please confirm that the wire to be used is within the range of the chosen crimping terminal.

As a rule, applicable wires for crimping connector are tin-plated annealed copper stranded wire. Bare copper wire, solid wire, tin-coated wire, shielded wire and so on are out of range. However, it is possible to use other wires if they are checked for compatibility with the chosen crimping terminal.

3. Control Points for Crimping Operation

Please check the following points to ensure that a correctly crimped terminal and wire combination is produced.

3.1 Checking Application Tooling

Read the “Operation/Handling Manuals” which are available for each press and application tool prior to commencing the crimping operation.

3.2 Stripping Wire Insulation Operation

As the wire stripping length is influenced by wire style, crimping method and so on, please set the proper stripping length according to processing condition. After setting the correct length depending on the terminal used, strip the insulation carefully by a wire stripper etc. without any damage to the wire conductors.

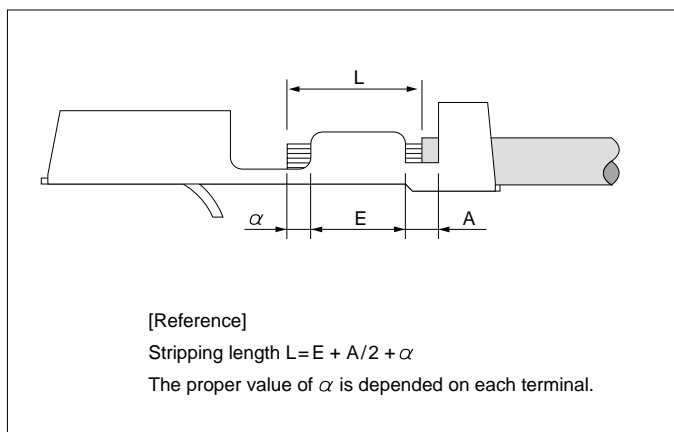

[Cautions]

- (1) Take care to prevent cutting of wire conductors, uneven stripping length and insufficient cutting of the insulation.
- (2) Ensure the strands do not spray come apart.
- (3) Do not excessively twist the strands.

Precaution for Crimping Process

3.3 Crimping Height

Crimping height is one of the important quality management items on crimping process. As crimping terminals without the correct crimp-height is the cause of poor conductivity, measure the crimp-height at the start, in the middle and at the end of the crimping process.

1) Measuring Method

Measure the crimping height of the crimped terminals with a specified crimp micrometer (designed by JST) at the center of the wire barrel and at the center of the insulation barrel.

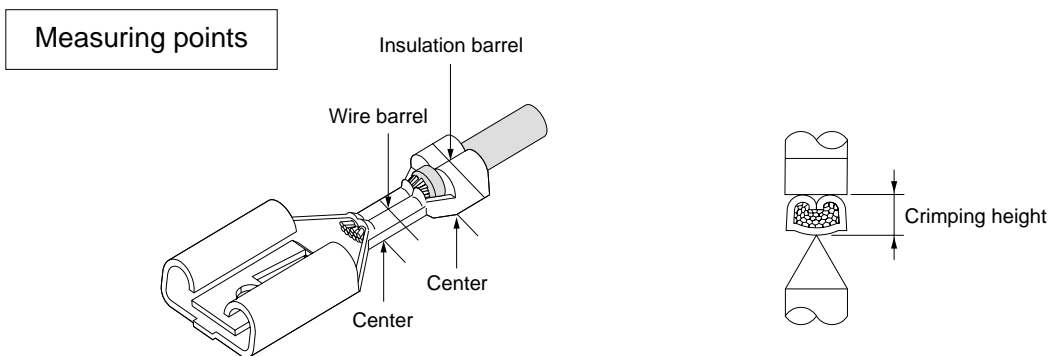

2) Crimping height for wire barrel

Set the crimping height of the wire conductor barrel within the range specified by JST.

3) Crimping height for insulation barrel

Adjust the crimping height of the insulation barrel in relation to the outer diameter of the wire insulation and wire type. Determine the range of crimping height for insulation barrel so that it is not crimped excessive nor too loosely.

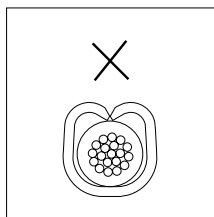

- Insufficient crimping
- Wire insulation is easily pulled from the terminal when applying tension to the wire.

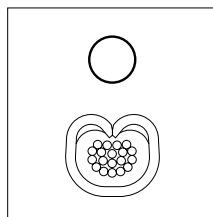

- Good

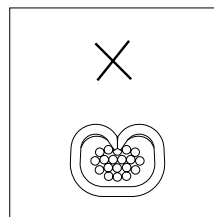

- Excessive crimping
- The barrel edges cut into the wire & damage the conductors.

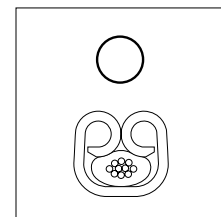

- Good

Check: Cut off the insulation support and remove the wire insulation, then check the wire conductors for damage.

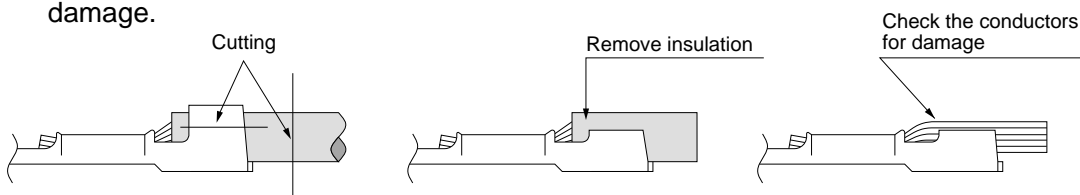

Precaution for Crimping Process

3.4 Crimped Appearance

Check crimped appearance visually (using loupe etc.) in order to confirm correct crimping condition. As the inspection items change with each terminal, an example is shown below. Check the Handling Manual for each terminal or connector about the specific details to be checked.

Bend up & Bend down

Check the angle of bend up or bend down at the wire barrel.

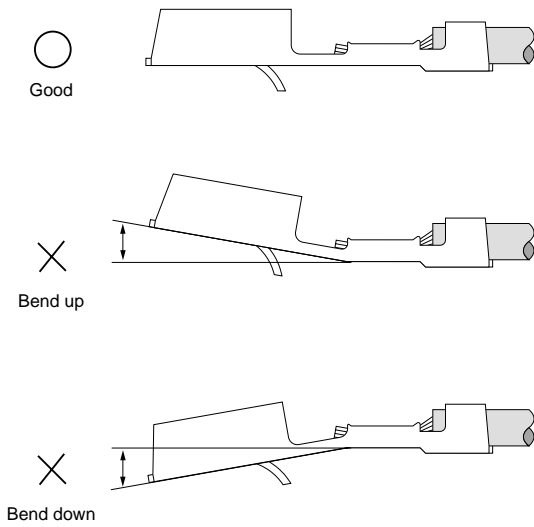

Twist

Check the angle of twist at the wire barrel.

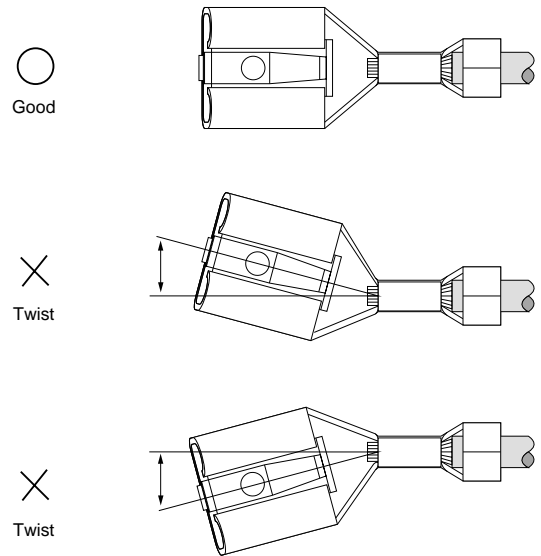

Rolling

Check the angle of rolling at the wire barrel.

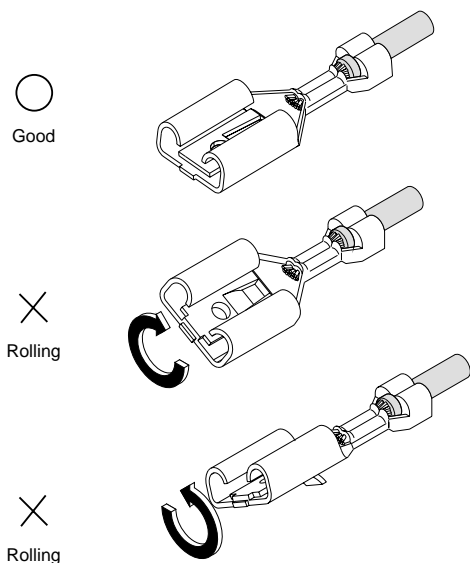

Uncrimped Conductor

Check that there are no uncrimped conductors at the wire barrel.

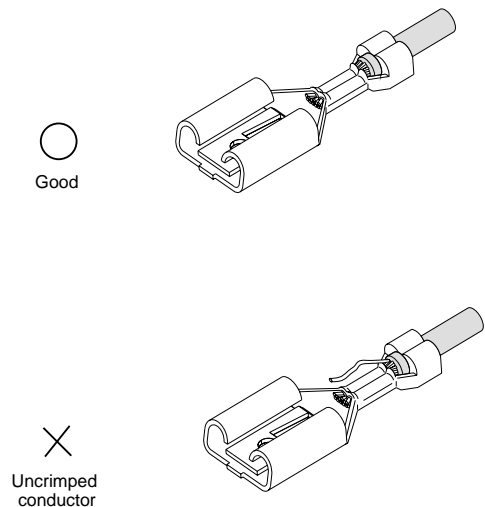

Precaution for Crimping Process

Bell-mouth

Check bell-mouth size.

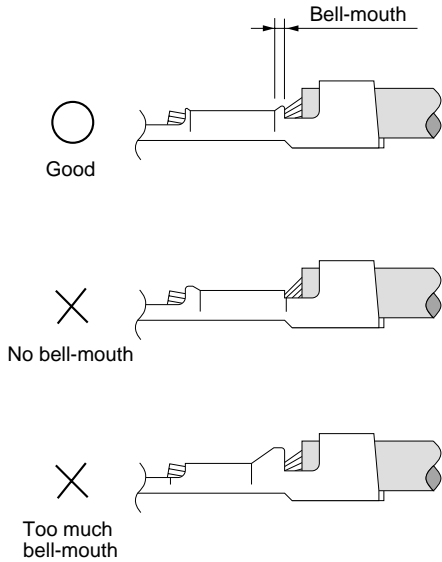

Cut-off Length

Check cut-off length.

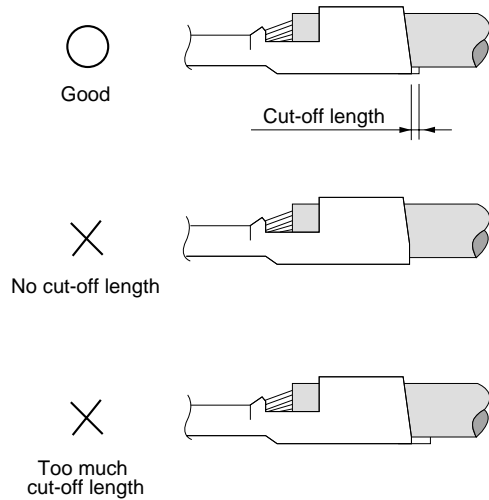

Wire Conductor Protruding Length

Check the conductors are crimped at the correct position of whole wire barrel.

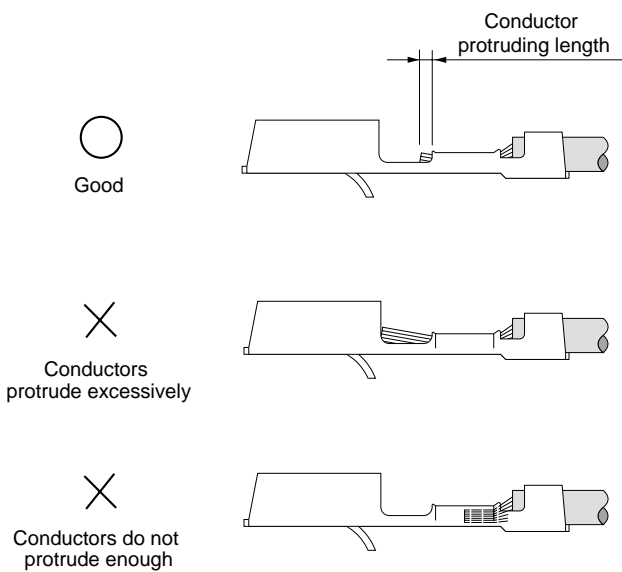

Wire Insulation Protruding Position

Check the wire insulation is held by the whole insulation barrel and crimped at the wire barrel, so that a "window" of conductor is seen between the wire and insulation barrel approximately 50/50.

